

WESTERN - SAN BERNARDINO WATERMASTER  
FOR

WESTERN MUNICIPAL WATER DISTRICT et al.

vs.

EAST SAN BERNARDINO COUNTY WATER DISTRICT et al.

CASE NO. 78426 - COUNTY OF RIVERSIDE

**ANNUAL REPORT**

**OF THE**

**WESTERN-SAN BERNARDINO WATERMASTER**

FOR

CALENDAR YEAR 2014

August 1, 2014

1 Western-San Bernardino Watermaster  
2 380 East Vanderbilt Way  
3 San Bernardino CA 92408  
4 909/387-9200

FILED  
SUPERIOR COURT OF CALIFORNIA  
COUNTY OF RIVERSIDE

AUG 01 2014

J. ALVAREZ

5 Douglas D. Headrick, Member  
6 Western-San Bernardino Watermaster

7  
8 SUPERIOR COURT OF THE STATE OF CALIFORNIA  
9 FOR THE COUNTY OF RIVERSIDE

10  
11  
12 WESTERN MUNICIPAL WATER )  
13 DISTRICT et al., )  
14 Plaintiffs, )  
15 v. )  
16 EAST SAN BERNARDINO )  
17 COUNTY WATER DISTRICT et al., )  
18 Defendants. )  
19 )  
20 )  
21 )  
22 )  
23 )  
24 )  
25 )  
26 )  
27 )  
28 )

*civ*  
CASE NO. 78426  
NOTICE OF LODGEMENT  
Annual Report of the  
Western-San Bernardino  
Watermaster  
with Appendices  
and Data Volumes  
for Calendar Year 2014  
dated August 1, 2014  
on Digital Video Disk

DATED: August 1, 2014

  
Douglas D. Headrick, Member  
Western-San Bernardino  
Watermaster

1 **Riverside Superior Court filing information:**

2 Place: main floor of the courthouse, 4050 Main Street, Riverside.

3 Contact person: Cynthia Carlton

4 Civil Clerk's Window F

951-955-3155

5 [cynthia.carlton@riverside.courts.ca.gov](mailto:cynthia.carlton@riverside.courts.ca.gov)

6

7

8

9

10

11

12

13

14

15

16

17

18

19

20

21

22

23

24

25

26

27

28

**WESTERN - SAN BERNARDINO WATERMASTER**

FOR

WESTERN MUNICIPAL WATER DISTRICT ET AL.

vs.

EAST SAN BERNARDINO COUNTY WATER DISTRICT ET AL.

CASE NO. 78426 - COUNTY OF RIVERSIDE

**DOUGLAS D. HEADRICK, Member**

380 East Vanderbilt Way  
San Bernardino, CA 92408  
Tel (909) 387-9200  
Fax (909) 387-9247

**JOHN V. ROSSI, Member**

14205 Meridian Parkway  
Riverside, CA 92518  
Tel (951) 571-7100  
Fax (951) 571-0592

August 1, 2014

TO: Clerk of Superior Court of Riverside County and All Parties

RE: Watermaster Report for Calendar Year 2014

We have the honor of submitting the Annual Report of the Western-San Bernardino Watermaster for Calendar Year 2014.

The provisions of Paragraph III and Paragraphs V through XII of the Judgment in Case No. 78426, entered April 17, 1969, became effective from and after January 1, 1971. The Judgment requires that the Watermaster report to the Court and to each Party in writing not more than seven months after the end of each year, or within such other time as the Court may fix, on each determination made by said Watermaster pursuant to the Judgment and such other items as the Parties may mutually request or the Watermaster may deem to be appropriate.

Accordingly, this report is submitted herewith under date of August 1, 2014, and presents the findings of the Watermaster for Calendar Year 2014 and summarizes the five-year period 2009 through 2013.

Pursuant to Judgment Paragraphs VI(b) and VI(c), Watermaster has increased the Safe Yield Adjusted Rights of Plaintiffs and San Bernardino Valley to include the New Conservation Allocation determined by Watermaster. Such determination is based on a forecast of the long term average annual new conservation expected to result from operation of the Seven Oaks Reservoir and increased recharge at the Santa Ana River spreading grounds commencing in 2013. The new Adjusted Rights are shown on Table Nos. 2 and 3A-1 through 3D-1.

Watermaster has also determined the amounts of new conservation available for extraction by Plaintiffs and users within San Bernardino Valley resulting from operation of the Seven Oaks Reservoir and increased recharge at the Santa Ana River spreading grounds for the period 1998 through 2012. Also, pursuant to Judgment Paragraph VI(b)2, Watermaster has verified that Plaintiffs have paid their proportionate share of the costs of such new conservation through December 31, 2013.

The allocation among Plaintiffs and San Bernardino Valley of forecast amounts of new conservation and amounts for prior years 1998 through 2012 are summarized in the following table.

**New Conservation Allocation**

Party	Forecast Amounts for Existing Conditions AF/yr	Amount for Prior Years 1998-2012 AF
City of Riverside	1,719	9,635
Riverside Highland Water Company	141	793
Meeks and Daley Water Company	258	1,448
The Regents of the University of California	18	98
San Bernardino Valley	<u>5,507</u>	<u>30,866</u>
<b>Total</b>	<b>7,643</b>	<b>42,840</b>

In order to make new conservation from prior years 1998 through 2012 available for extraction by Plaintiffs and users in San Bernardino Valley, Western and San Bernardino Valley entered an agreement dated July 17, 2013 titled, "2013 Agreement Regarding Additional Extractions of New Conservation Water from the San Bernardino Basin Area". Watermaster will account for such additional extractions in Table Nos. 2, 3A-2 through 3D-2 and 17B-1 through 17B-5 commencing in 2013.

During preparation of the Annual Report for Calendar Year 2011, issues were identified regarding Table Nos. 16, 17 and 18. Watermaster resolved the issues in the Calendar Year 2012 Annual Report and resolution of the issues has resulted in modifications of the Annual Report that are described in Chapters II, III, VII, VIII and IX. Such modifications required revision of determinations commencing in 1971 and reduced the amount of credit available to Western and San Bernardino Valley to offset future obligations. After revision there is still credit available in all years commencing in 1971. Therefore, no replenishment would have been required in any prior year had the modifications been in place since 1971.

In conclusion, Table No. 18 shows that during the five-year period 2009 through 2013, Plaintiffs did not exceed the allowable extractions and that Western and San Bernardino Valley credits exceed obligations and therefore neither district is required to provide replenishment.

We, and each of us, hereby certify that this is a true and correct Report of the Watermaster for work performed by us, and under our supervision, for Calendar Year 2014 pursuant to the requirements of the Judgment.

Respectfully submitted,

WESTERN-SAN BERNARDINO WATERMASTER

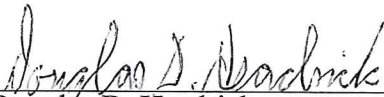
By   
 \_\_\_\_\_  
 Douglas D. Headrick

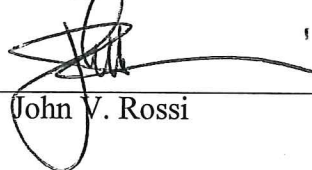
  
 \_\_\_\_\_  
 John V. Rossi

WESTERN - SAN BERNARDINO WATERMASTER  
FOR

WESTERN MUNICIPAL WATER DISTRICT et al.

vs.

EAST SAN BERNARDINO COUNTY WATER DISTRICT et al.

CASE NO. 78426 - COUNTY OF RIVERSIDE

**ANNUAL REPORT**

**OF THE**

**WESTERN-SAN BERNARDINO WATERMASTER**

FOR

CALENDAR YEAR 2014

August 1, 2014

## TABLE OF CONTENTS

	Page
Letter of Transmittal	
CHAPTER I – INTRODUCTION.....	1
Scope of Report .....	2
History of Litigation.....	2
Summary of Judgment No. 78426.....	5
CHAPTER II - WATERMASTER ACTIVITIES.....	9
Groundwater Extractions.....	9
Distribution of Extractions.....	10
Groundwater Level Measurements .....	11
Stream Flow and Water Quality Measurements.....	12
Field Inspections .....	12
Western Extractions from the San Bernardino Basin Area.....	13
Watermaster Collaborative Advisory Process .....	13
2013 and 2014 Annual Report Modifications.....	14
CHAPTER III - EXTRACTIONS FROM THE SAN BERNARDINO BASIN AREA.....	24
2013 and 2014 Annual Report Modifications – Table Nos. 2 and 3.....	28
CHAPTER IV - NATURAL SAFE YIELD OF THE SAN BERNARDINO BASIN AREA AND ADJUSTED RIGHTS OF PLAINTIFF EXPORTERS.....	65

TABLE OF CONTENTS  
(continued)

	Page
CHAPTER V - EXTRACTIONS FROM COLTON BASIN AREA AND RIVERSIDE BASIN AREA WITHIN SAN BERNARDINO COUNTY .....	68
For Use Outside San Bernardino Valley.....	68
For Use Within San Bernardino Valley .....	68
Minimum Groundwater Surface Elevations .....	78
CHAPTER VI - EXTRACTIONS FROM THE PORTION OF RIVERSIDE BASIN AREA WITHIN RIVERSIDE COUNTY WHICH IS TRIBUTARY TO THE RIVERSIDE NARROWS .....	83
Extractions .....	83
Return Flows.....	88
CHAPTER VII - EXTRACTIONS FROM THE SAN BERNARDINO BASIN AREA, COLTON BASIN AREA, AND RIVERSIDE BASIN AREA FOR USE WITHIN WESTERN ON LANDS THAT ARE NOT TRIBUTARY TO THE RIVERSIDE NARROWS .....	90
2013 and 2014 Annual Report Modifications – Table No. 8 .....	90
CHAPTER VIII - EXTRACTIONS FROM THE SAN BERNARDINO BASIN AREA FOR USE ON LANDS NOT WITHIN WESTERN NOR TRIBUTARY TO THE RIVERSIDE NARROWS AND FOR USE ON LANDS WITHIN THE COLTON AND RIVERSIDE BASIN AREAS .....	95
Deliveries to Chino Basin .....	95
Deliveries to Areas Other Than Chino Basin.....	95
Deliveries to Lands Within the Colton and Riverside Basin Areas.....	96
2013 and 2014 Annual Report Modifications – Table Nos. 9A and 9B and Volume 7.....	96



TABLE OF CONTENTS  
(continued)

	Page
CHAPTER IX - ANNUAL ACCOUNTING OF EXTRACTIONS, DELIVERIES, AND REPLENISHMENT OBLIGATIONS .....	105
Plaintiff Extractions from San Bernardino Basin Area .....	105
Allowable Plaintiff Extractions in 2014.....	106
Non-Plaintiff Extractions from San Bernardino Basin Area.....	107
Total Extractions from the San Bernardino Basin Area .....	108
Export to Areas Not Tributary to Riverside Narrows and Deliveries to Colton and Riverside Basin Areas .....	108
Summary of Western Credits and Obligations .....	109
Summary of San Bernardino Valley Credits and Obligations .....	110
Annual Accounting of Additional Extractions .....	111
Summary of Compliance .....	117
2013 and 2014 Annual Report Modifications – Table Nos. 10 through 18 .....	119

## TABLES

No.	Title	Page
1	Costs to the Parties for USGS Surface Water Measurements Used by Western - San Bernardino Watermaster – November 1, 2013 to October 31, 2014 .....	23
2	Adjusted Right to Extract and Verified Extractions of Other Than Plaintiffs From the San Bernardino Basin Area .....	36-40
3A-1	Adjusted Right of City of Riverside to Extract From the San Bernardino Basin Area For Use in Each Service Area.....	41-43
3A-2	Verified Extractions by City of Riverside From the San Bernardino Basin Area For Delivery to Each Service Area .....	44-46
3B-1	Adjusted Right of Riverside Highland Water Company to Extract From the San Bernardino Basin Area For Use in Each Service Area .....	47-49
3B-2	Verified Extractions by Riverside Highland Water Company From the San Bernardino Basin Area For Delivery to Each Service Area .....	50-52
3C-1	Adjusted Right of Agua Mansa Water Company and Meeks & Daley Water Company to Extract From the San Bernardino Basin Area For Use in Each Service Area .....	53-55
3C-2	Verified Extractions by Agua Mansa Water Company and Meeks & Daley Water Company From the San Bernardino Basin Area For Delivery to Each Service Area.....	56-58
3D-1	Adjusted Right of The Regents of the University of California to Extract From the San Bernardino Basin Area For Use in Each Service Area .....	59-61
3D-2	Verified Extractions by The Regents of the University of California From the San Bernardino Basin Area For Delivery to Each Service Area.....	62-64
4	Verified Extractions From Colton Basin Area by San Bernardino and Riverside County Entities For Use in Each County .....	70-73
5	Verified Extractions from Riverside Basin Area Within San Bernardino County by San Bernardino and Riverside County Entities For Use in Each County .....	74-77
6	Verified Extractions From Riverside Basin Area Within Riverside County For Use in Riverside County .....	84-87

TABLES  
(Continued)

No.	Title	Page
7	Reduction in Return Flow Contributing to Base Flow at Riverside Narrows Resulting From Conversion of Agricultural Uses of Water to Domestic Uses Connected to a Sewage System Discharging to the River Below Riverside Narrows .....	89
8	Verified Extractions From the San Bernardino Basin Area, the Colton Basin Area, and the Riverside Basin Area For Use Within Western on Lands That Are Not Tributary to the Riverside Narrows.....	94
9A	Verified Extractions from the San Bernardino Basin Area For Use on Lands Not Within Western Nor Tributary to Riverside Narrows.....	103
9B	Verified Extractions from the San Bernardino Basin Area For Use on Lands Within Colton and Riverside Basin Areas .....	104
10	Annual Accounting of Extractions by the City of Riverside From the San Bernardino Basin Area For Delivery to Each Service Area .....	130-135
10A	Allowable Extractions by the City of Riverside From the San Bernardino Basin Area For Delivery to Each Service Area .....	136-137
11	Annual Accounting of Extractions by Riverside Highland Water Company From the San Bernardino Basin Area For Delivery to Each Service Area .....	138-143
11A	Allowable Extractions by Riverside Highland Water Company From the San Bernardino Basin Area For Delivery to Each Service Area .....	144-145
12	Annual Accounting of Extractions by Agua Mansa Water Company and Meeks & Daley Water Company From the San Bernardino Basin Area For Delivery to Each Service Area.....	146-151
12A	Allowable Extractions by Agua Mansa Water Company and Meeks & Daley Water Company From the San Bernardino Basin Area For Delivery to Each Service Area .....	152-153

TABLES  
(Continued)

No.	Title	Page
13	Annual Accounting of Extractions by The Regents of The University of California From the San Bernardino Basin Area For Delivery to Each Service Area .....	154-159
13A	Allowable Extractions by The Regents of The University of California From the San Bernardino Basin Area For Delivery to Each Service Area .....	160-161
14	Annual Accounting for Western Municipal Water District Export of Extractions From San Bernardino Basin Area, Colton Basin Area, and Riverside Basin Area for Use Within Western on Lands That Are Not Tributary to the Riverside Narrows.....	162
15A	Annual Accounting for San Bernardino Valley Municipal Water District Export of Extractions from San Bernardino Basin Area For Use on Lands Not Within Western Nor Tributary to the Riverside Narrows .....	163
15B	Annual Accounting for San Bernardino Valley Municipal Water District Delivery of Extractions from San Bernardino Basin Area For Use on Lands Within Colton and Riverside Basin Areas .....	164
16	Annual Accounting for Western Municipal Water District Extractions From Colton Basin Area and Riverside Basin Area Within Riverside and San Bernardino Counties for Use Outside San Bernardino Valley .....	165-166
17	Annual Accounting for San Bernardino Valley Municipal Water District Extractions From San Bernardino Basin Area .....	167-168
17A	Annual Accounting for Additional Extractions of Imported Water From San Bernardino Basin Area by Western Municipal Water District .....	169-170
17B-1	Annual Accounting for Additional Extractions of New Conservation Water and Imported Water From San Bernardino Basin Area by City of Riverside .....	171-172
17B-2	Annual Accounting for Additional Extractions of New Conservation Water and Imported Water From San Bernardino Basin Area by Riverside Highland Water Company.....	173-174

TABLES  
(Continued)

No.	Title	Page
17B-3	Annual Accounting for Additional Extractions of New Conservation Water and Imported Water From San Bernardino Basin Area by Agua Mansa Water Company and Meeks & Daley Water Company.....	175-176
17B-4	Annual Accounting for Additional Extractions of New Conservation Water and Imported Water From San Bernardino Basin Area by The Regents of The University of California.....	177-178
17B-5	Annual Accounting for Additional Extractions of New Conservation Water From San Bernardino Basin Area by Entities In San Bernardino County Other Than Plaintiffs .....	179-180
17C	Annual Accounting for Riverside Basin Mitigation Account Related to Seven Oaks Water Conserved in San Bernardino Basin Area.....	181-182
18	Summary of Compliance With Four Principal Provisions of the Judgment .....	183

## FIGURES

No.	Title	Page
1	Groundwater Surface Elevation Johnson No. 1 Well (1S/4W-21Q03S) - 2014.....	80
2	Groundwater Surface Elevation Flume No. 2 Well (1S/4W-29H01S) - 2014 .....	81
3	Groundwater Surface Elevation Flume No. 5 Well (1S/4W-29Q01S) - 2014 .....	82

## MAPS

No.	Title	Page
1	Boundaries of Groundwater Basins .....	8
2	Location of Key Wells .....	79

## DIAGRAMS

No.	Title	Page
1	Organization of Annual Report.....	19-22

## APPENDICES (Appendices Separately Compiled)

No.	Title
A	Annual Report Table Nos. 2 Through 17 that Include Data For All Years Commencing in 1971
B	Volume 1, Table 8 and Volume 7 Tables

REPORT OF WATERMASTER  
VOLUMES  
(Each Volume Separately Compiled)

- Volume 1    Verified Extractions from the San Bernardino Basin Area By Non-Plaintiffs for Use Within San Bernardino County
- Volume 1A    Verified Extractions from the San Bernardino Basin Area By Plaintiffs
- Volume 2    Verified Extractions from the Colton Basin Area
- Volume 3    Verified Extractions from the Riverside Basin Area Within San Bernardino County
- Volume 4    Verified Extractions from the Riverside Basin Area Within Riverside County
- Volume 5    Distribution of Extractions
- Volume 6    Verified Extractions from the San Bernardino Basin Area, Colton Basin Area, and Riverside Basin Area for Use Within Western on Lands Not Tributary to the Riverside Narrows
- Volume 7    Verified Extractions from the San Bernardino Basin Area for Use on Lands Not Within Western Nor Tributary to the Riverside Narrows and for Use on Lands Within Colton and Riverside Basin Areas
- Volume 8    Groundwater Surface Elevations of Wells Numbered 1S/4W-21Q3, 1S/4W-29H1 and 1S/4W-29Q1 Located Within the Colton Basin Area and Riverside Basin Area Within San Bernardino County

**CHAPTER I**  
**INTRODUCTION**



# **CHAPTER I**

## **INTRODUCTION**

Provisions of the physical solution set forth in the Judgment in Case No. 78426, Western Municipal Water District of Riverside County et al., vs. East San Bernardino County Water District et al., entered April 17, 1969, in the Superior Court of the State of California in and for the County of Riverside, established the entitlements and obligations of the two major water districts overlying the San Bernardino, Colton, and Riverside groundwater basins, namely San Bernardino Valley Municipal Water District (San Bernardino Valley) and Western Municipal Water District of Riverside County (Western).

The Court appointed a Watermaster, composed of two persons, to administer and enforce the provisions of the Judgment and to report annually to the Court and the Parties. Douglas D. Headrick was appointed by the Court on January 22, 2014 to replace Samuel H. Fuller as the representative from San Bernardino Valley. John V. Rossi continues as the representative from Western.

The provisions of the Judgment became effective January 1, 1971; however, progress reports were filed with the Court for calendar years 1969, 1970, and 1971 reporting on the progress of verifications and initial determinations required by the Judgment. This report for calendar year 2014 includes a description and summary of the work completed during 2014 and also includes the annual accounting of extractions from the San Bernardino, Colton and Riverside Basin Areas and the distribution of such extractions to the various service areas for calendar year 2013. The scope of this report for 2014 and a history of the litigation leading to the physical solution settling the case are set forth in some detail in succeeding paragraphs.

## **Scope of Report**

Paragraph XIII(e) of the Judgment requires the Watermaster to report to the Court and each Party not more than seven months after the end of each year.

The Annual Reports of the Western-San Bernardino Watermaster for calendar years 1969 through 1971 reported on the verifications and initial determinations required by the Judgment including the safe yield of the San Bernardino Basin Area and the determination of the Adjusted Rights of the Plaintiffs. Beginning with the 1972 Report, the Watermaster began the annual accounting in accordance with the Judgment provisions. This report presents the activities of the Watermaster for calendar year 2014 together with the annual accounting of extractions and deliveries for calendar year 2013.

## **History of Litigation**

Before the turn of the twentieth century, the various water service organizations diverting surface water from the Santa Ana River and pumping from the underground water basins supplied by the underflow of the Santa Ana River and its tributaries have from time to time engaged in litigation over water rights within the San Bernardino, Riverside and Orange County areas.

On October 18, 1963, the Orange County Water District (OCWD) filed suit against the City of Chino and others in the Superior Court of the State of California in and for the County of Orange (Orange County Court), seeking an adjudication of water rights against more than 2,500 water users in the Santa Ana River Watershed tributary to Prado Dam. Included among the defendants were the Chino Basin Municipal Water District (now Inland Empire Utilities Agency), Western Municipal Water District of Riverside County (Western), and San Bernardino Valley Municipal Water District

(San Bernardino Valley). Thirteen cross complaints were filed in 1968, which extended the adjudication to more than 1,500 water users in the area downstream from Prado Dam, which included OCWD. Thus, some 4,000 parties were involved in the suit, including the three upper districts and OCWD.

With a case of this magnitude, it became obvious that every effort should be made to arrive at an equitable settlement and a physical solution in order to obviate the enormous expense and unwieldy litigation which would be involved if the case were brought to trial.

Attorneys and engineers representing the four major districts and a large number of the defendants worked diligently in order to effect a settlement and some type of physical solution which would prove acceptable to all Parties.

As a result, in May of 1968, an outline of a proposal for settlement of the case was prepared and a committee, composed of attorneys and engineers for the Parties, commenced preparation of the settlement documents.

In June 1968, the Orange County Court held a hearing on the motions which it had received requesting a preliminary injunction and an order of reference. The plaintiff OCWD, however, was concerned with the necessity of bringing the case to trial within the statutory period, and therefore, on July 15, 1968, submitted a motion to set the complaint in the case for trial. On October 15, 1968, the trial was commenced and adjourned after a half day of testimony on behalf of the Plaintiff.

Shortly thereafter, the Parties filed settlement documents with the Orange County Court, including a stipulation for Judgment, and on April 17, 1969, the Court entered the stipulated Judgment, thus terminating the many years of controversy over water rights along the Santa Ana River involving the issues and Parties included in the case of Orange County Water District vs. City of Chino, et al.

During the settlement negotiations, it became apparent that the San Bernardino Valley entities would participate only in a part of the Orange County settlement, in the belief that they had no responsibility for the waters of the Santa Ana River downstream from the point of rising water at Riverside Narrows. Therefore, the settlement of the OCWD action established an obligation of San Bernardino Valley for the delivery of 15,250 acre-feet of Base Flow annually at the Riverside Narrows, subject, however, to adjustment for quality.

As a result of the Orange County settlement, it became apparent that a second settlement would be necessary between the Riverside and San Bernardino entities who diverted water from the Santa Ana River surface and groundwater sources supplied by the Santa Ana River and tributaries above the Riverside Narrows.

For some time, increasing withdrawals from groundwater resources above Bunker Hill Dike (San Jacinto Fault), which supplied in large part the water requirements of San Bernardino and Redlands as well as the Riverside exporters, had been the cause of concern to the exporters in Riverside County. As a result, on March 1, 1963, a suit was filed by Western and others, in the Superior Court of the State of California in and for the County of Riverside (Riverside Court) seeking a general adjudication of water rights within the San Bernardino Basin Area. This suit preceded the filing of the Orange County suit, and it was decided that this suit could well be used as a vehicle for a physical settlement between Riverside and San Bernardino interests.

Following extensive negotiations between Riverside and San Bernardino interests, a physical settlement was completed and documents delineating the settlement were entered in the Riverside Court on April 17, 1969, being Judgment No. 78426.

On February 28, 1992 the Court approved an amendment to the Judgment that primarily addressed an issue regarding new export (Judgment Paragraph X). The amendment is referred to herein as the 1992 Amendment. A redline version of the 1969 Judgment showing the 1992 amendments can be found on the Western-San Bernardino Watermaster Annual Report DVD.

### **Summary of Judgment No. 78426**

The physical solution as agreed upon and as set forth in the Judgment states that all instructions and orders of the Riverside Court are to be administered and enforced by a Watermaster consisting of a committee of two persons, one of whom shall be nominated by San Bernardino Valley and the other by Western and appointed by the Court.

The Judgment directed the Watermaster to make certain initial determinations and to verify the amounts of water diverted and pumped from streams and groundwater basins embraced by the Judgment where such amounts had been assumed for purposes of the Judgment. Upon completion of the verifications and initial determinations, compliance with the Judgment requires an annual accounting of groundwater and surface water flows and diversions within the various basins in order that the Watermaster may properly report to the Riverside Court the comparisons of the year-by-year operations with the verified entitlements and an accounting as to the replenishment obligations or credits indicated by such comparison. The items verified or determined initially and to be reported on annually are as follows:

	<b>Watermaster Determinations Required by Judgment</b>	<b>Verified for Five Calendar Years Ending with 1963</b>	<b>To be Determined Annually from and after 1971</b>
1.	Total actual average annual extractions from the San Bernardino Basin Area by entities other than Plaintiffs for use within San Bernardino County.	X	X
2.	The natural safe yield of the San Bernardino Basin Area based upon the cultural conditions equivalent to those existing during the five-calendar year period ending with 1963.	1	1
3.	The annual "adjusted right" of each exporter (Plaintiff) to extract water from the San Bernardino Basin Area based upon the percentage of the natural safe yield determined by the methods used in Table B-2 of the Judgment.	X	
4.	The annual production by Plaintiffs for comparison with adjusted right determined in item 3 next preceding.		X
5.	Annual discharge from the City of San Bernardino Water Quality Control Plant to the River as to quantity and quality.	2	X
6.	Average annual extractions from the Colton Basin Area for use outside San Bernardino Valley.	X	X
7.	Average annual extractions from the Riverside Basin Area within San Bernardino County for use outside San Bernardino Valley.	X	X
8.	The average static water level within the Colton Basin and Riverside Basin within San Bernardino County as determined by the three wells listed in Judgment.	3	X

	Watermaster Determinations Required by Judgment	Verified for Five Calendar Years Ending with 1963	To be Determined Annually from and after 1971
9.	The average annual extractions from that portion of the Riverside Basin Area in Riverside County which is tributary to the Riverside Narrows for use in Riverside County.	X	X
10.	Annual amounts of water extracted for use within Western from the San Bernardino Basin Area and the area downstream therefrom to the Riverside Narrows which have been exported for use outside the area tributary to the Riverside Narrows.	X	X
11.	Annual amount of water extracted from the San Bernardino Basin Area for use within San Bernardino County on lands which are not tributary to the Riverside Narrows and for use on lands within Colton and Riverside Basin Areas.	4	X
12.	Reduction in return flow now contributing to base flows at Riverside Narrows which results from conversion of agriculture using water within Western to domestic or other uses connected to sewage or waste disposal system, the effluent from which is not tributary to the rising water at Riverside Narrows.	5	X

1 Determined initially by supplemental order of the Court to be 232,100 acre-feet per annum. Such amount is subject to the continuing jurisdiction of the Court.

2 Assumed for purposes of Judgment to be 16,000 acre-feet annually, verification not required.

3 Established at 822.04 feet above sea level, based on fall season of 1963.

4 Revised by Watermaster during preparation of the Annual Report for calendar years 1974 and 2012, in accordance with the 1992 Amendment.

5 Average for 5 years ending with 1963 established by Judgment to be 3,916 acres; verification not required.

The foregoing initial determinations and verifications required by the Judgment have been completed and were reported in the *Annual Report* of the *Western-San Bernardino Watermaster for Calendar Years 1971 and 1972* and continue to be reported in each Annual Report of the Watermaster. Map No. 1 shows the boundaries of the groundwater basins covered by the Judgment.

# MAP NO.1 - BOUNDARIES OF GROUNDWATER BASINS

8

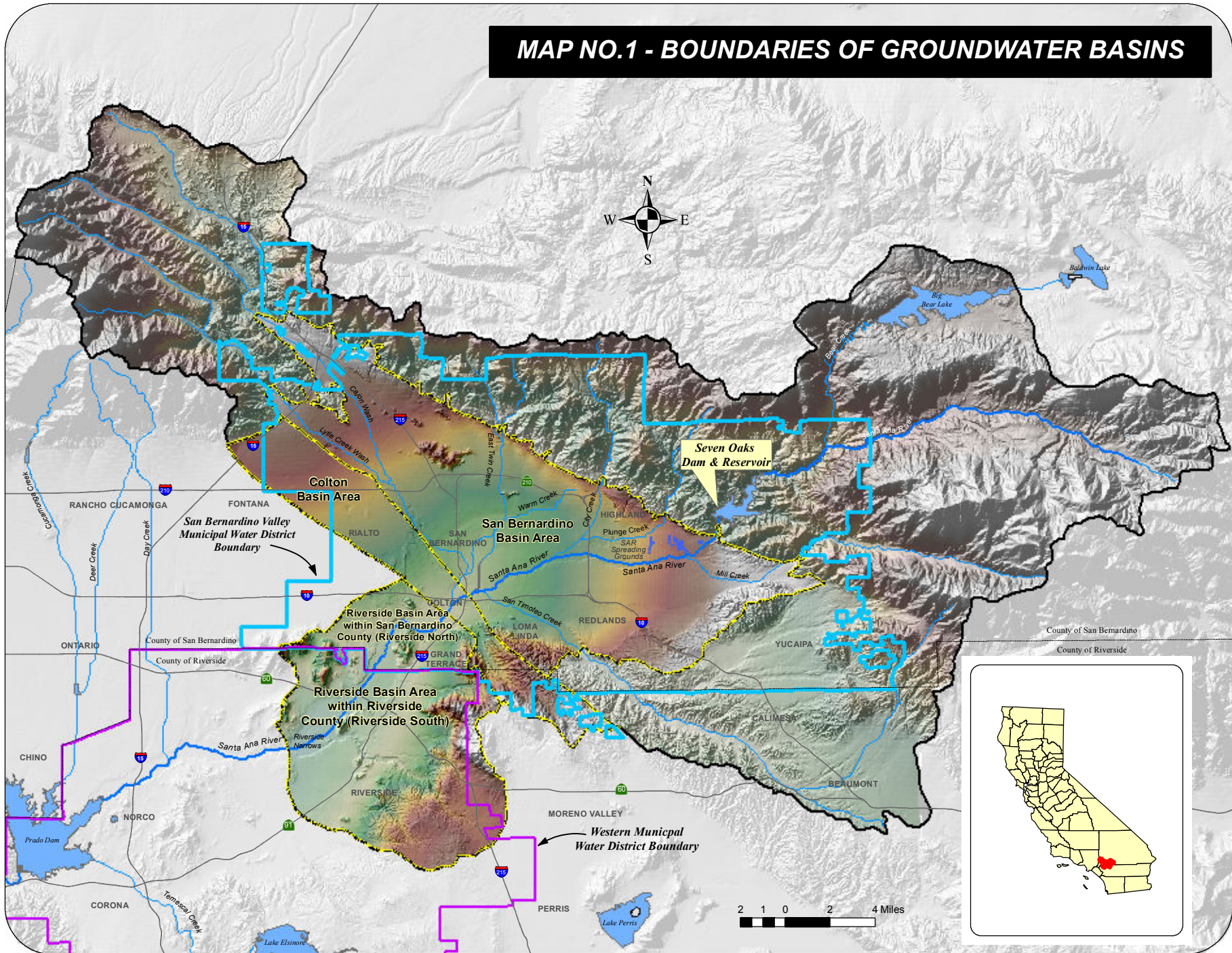

Path: Y:\2014\1703\_SanBernardinoWesternWatermaster\MapNo1Basins.mxd



**CHAPTER II**  
**WATERMASTER ACTIVITIES**

## **CHAPTER II**

### **WATERMASTER ACTIVITIES**

The Watermaster activities have included principally the collection, tabulation, and analysis of data, the maintenance of records, and the preparation of the Annual Report which presents the determinations and findings of the Watermaster as required by the Judgment.

The Annual Report is comprised of this summary document, separately compiled appendices and nine separately compiled data documents identified as Report of Watermaster, Volumes 1, 1A, and 2 through 8 that can be found on the Western-San Bernardino Watermaster Annual Report DVD. Appendix A is a compilation of Annual Report Table Nos. 2 through 17 for 1971 to present. Appendix B is Volume 1, Table No. 8 and numerous tables in Volume 7 for 1971 to present. All appendices are in PDF format from which the data can be copied/converted electronically. Volumes 1 through 8 are the sources of data used to construct Tables Nos. 2 through 18 in this report and include hundreds of pages of raw data and calculations.

The Organization of Annual Report (Diagram No. 1), included at the end of this chapter, identifies which of the Volumes 1 through 8 is a source of data for each of the Annual Report Table Nos. 2 through 18. The diagram shows how hundreds of pages of data and calculations are summarized in the Annual Report tables. Annual Report Table Nos. 2 through 17 are used to address the four basic questions regarding compliance with four general provisions of the Judgment in Table No. 18 highlighted in blue at the bottom of the diagram.

#### **Groundwater Extractions**

The most important data required for implementing the provisions of the Judgment are the annual tabulations of the groundwater extractions and surface

water diversions made within the San Bernardino, Colton, and Riverside Basin Areas. These extractions and diversions were initially determined and verified for the 1959-63 Base Period and were assembled and summarized in the June 1972 Report of Watermaster; Volume 1, titled *Verification of Extractions from San Bernardino Basin Area By Non-Plaintiffs*; Volume 1A, titled *Verification of Extractions from the San Bernardino Basin Area by Plaintiffs*; Volume 2, titled *Verification of Extractions from Colton Basin Area*; Volume 3, titled *Verification of Extractions from Riverside Basin Area Within San Bernardino County*; and Volume 4, titled *Verification of Extractions from Riverside Basin Area Within Riverside County*. The Watermaster has established a system for tabulating annual notices of groundwater extractions and surface diversions filed with the State Water Resources Control Board or, since calendar year 2005, with the Watermaster. The filed data are verified by the Watermaster and provide the basis for the annual accounting of extractions as required by the Judgment. Such extractions have been determined for calendar year 2013 and are summarized herein. Listings of the verified extractions by each individual owner for calendar year 2013 are assembled in Report of Watermaster, Volumes 1-2013, 1A-2013, 2-2013, 3-2013, and 4-2013.

### **Distribution of Extractions**

In addition to the annual accounting of the extractions from each basin, the Judgment also requires a determination as to the distribution of such extractions to the various service areas.

The distribution of verified extractions from the Colton and Riverside Basin Areas and the distribution of the Plaintiffs' extractions from the San Bernardino Basin Area were determined initially for the 1959-63 base period, and were reported in the June 1972 Report of Watermaster, Volume 5, titled *Distribution of Extractions*. Such distribution has been determined for calendar year 2013 and

is summarized herein. Detailed work sheets are assembled in Report of Watermaster, Volume 5-2013.

The Watermaster is also required to determine the amount of water extracted from each of the various Basin Areas and delivered to areas not tributary to Riverside Narrows. Such amounts fall into two classifications, described as follows:

- 1) extractions from the San Bernardino Basin Area, Colton Basin Area, and Riverside Basin Areas for use within Western on lands not tributary to the Riverside Narrows, as reported in Volume 6-2013, or
- 2) extractions from the San Bernardino Basin Area for use on lands not within Western nor tributary to the Riverside Narrows, as reported in Volume 7-2013.

The amount of water extracted and delivered under Classification No. 1 was determined initially for the 1959-63 Base Period and was reported in the Report of Watermaster, Volume 6, dated June 1972. The amount determined for calendar year 2013 is summarized herein. Detailed work sheets are assembled in the Report of Watermaster, Volume 6-2013.

The amount of water extracted and delivered under Classification No. 2 was determined for the 1959-63 Base Period and the additional years 1970 and 1971 and was published in the Report of Watermaster, Volume 7, dated February 1973. The amount was revised in Report of Watermaster, Volume 7, published September 6, 2013. The amount determined for calendar year 2013 is summarized herein. Detailed work sheets are assembled in the Report of Watermaster, Volume 7-2013.

### **Groundwater Level Measurements**

Groundwater surface elevation data required for three key wells located in the Colton Basin Area and the Riverside Basin Area within San Bernardino County are currently furnished by the City of Riverside and Western.

These data are shown in both tabular and graphical form for calendar years 1963 through 2013 in Volume 8 of previous Watermaster reports. The determination for calendar year 2014 is shown in the Report of Watermaster, Volume 8-2013.

### **Stream Flow and Water Quality Measurements**

The program of stream flow measurements conducted by the United States Geological Survey (USGS) in cooperation with the Watermaster has continued to provide basin inflow and stream diversion data.

The Western-San Bernardino Watermaster participates with the Santa Ana River Watermaster in part of the expense of the cooperative program with the USGS on surface water gages and water quality monitors at various locations. These expenses are presented in reports filed by the Santa Ana River Watermaster. The costs incurred for stream flow data collected and analyzed by the USGS on behalf of the Western-San Bernardino Watermaster are set forth in Table No. 1.

### **Field Inspections**

During the verification of the 2013 extractions from the San Bernardino, Colton and Riverside Basin Areas, some of the pumping facilities installed for extraction of groundwater and diversion of surface water were visited by members of the Watermaster or their representatives. Contact was made with some of the extractors to review their methods of computing extractions for the annual reports that were filed with the Watermaster.

During the initial verification program in the San Bernardino Basin Area, it was found that some groundwater producers and several diverters of surface water did not file their extractions and diversions with the State Water Resources Control Board. This condition was found to exist in some locations during the current year, which again necessitated inspection trips and contacts with various owners by the Watermaster members or their representatives.

### **Western Extractions From the San Bernardino Basin Area**

In 2004, Western and San Bernardino Valley implemented Paragraphs VI(b)6 and XV(a) of the Judgment to provide replenishment of the San Bernardino Basin Area with imported water and subsequent extraction for use within Western. Under these provisions of the Judgment and the August 18, 2004 Paragraph VI(b)6 agreement with San Bernardino Valley, Western acquired 3,500 acre-feet of imported water in 2004, 2,500 acre-feet in 2005 and 2,459 acre-feet in 2009 for replenishment of the San Bernardino Basin Area. Table No.17A accounts for such replenishment and any subsequent extractions by Western or Plaintiffs. In Table No. 17A, the net accumulated excess of replenishment over extractions is shown as a Credit, and Western may extract up to 6,000 acre-feet, at any future time, and may transfer such right to extract to any Plaintiff, pursuant to the Paragraph VI(b)6 agreement dated August 18, 2004. Such transfers and extractions are shown on Table Nos. 3A-2 through 3D-2 as Additional Deliveries.

### **Watermaster Collaborative Advisory Process**

The Watermaster is improving the ways in which it prepares and presents the information required under the Judgment to the Court, the Parties and other interested individuals. The Watermaster invited all interested persons and agencies to participate in a collaborative advisory process and on June 24, 2010 conducted the first Western-San Bernardino Watermaster Collaborative Advisory Process meeting. The Watermaster is continuing to meet with all interested parties in the collaborative process. Numerous topics have been discussed at the meetings, including: Watermaster accounting procedures, the safe yield and the natural safe yield of the San Bernardino Basin Area, water resource activities within the San Bernardino Basin Area, basin management, conjunctive use and

new conservation. The participants have elected to further refine groundwater basin and surface water hydrology models to better understand the operational characteristics of the San Bernardino Basin Area and for use in calculating new conservation.

### **2013 and 2014 Annual Report Modifications**

One of the principal efforts of Watermaster and the collaborative group for the past two years has been to make new conservation water resulting from operation of Seven Oaks Reservoir available for extraction and use by Plaintiffs and users within San Bernardino Valley. The determination of the amount of new conservation was the initial element of work. Developing a methodology for making the water available for extraction and accounting for its use in the Annual Report has been another major element.

As the work progressed, it quickly became apparent that Annual Report tables needed to be modified to include new conservation. However, it also became apparent that changes unrelated to new conservation could be made to make the report more accurate, more readable and more useful as a source of water resource data.

Report sections describing modifications have been added at the end of Chapter III, Chapter VII, Chapter VIII and Chapter IX to describe changes relevant to provisions of the Judgment addressed in each of these chapters.

Chapter III includes modifications to Table Nos. 2 and 3 to accomplish the following:

- 1) to make available to Plaintiffs and San Bernardino Valley, new conservation water resulting from operation of Seven Oaks Reservoir through further adjustment of the Adjusted Right pursuant to Judgment Paragraphs VI(b) and VI(c),

- 2) to account for extraction of new conservation water, including any such water made available by agreement between Western and San Bernardino Valley pursuant to Judgment Paragraph VI(b)6,
- 3) to improve understanding and readability of the Annual Report by relocating the accounting for high groundwater mitigation program related extractions from footnotes in Table Nos. 2, 10 through 13 and 17 to columns in Table Nos. 2 and 3, and
- 4) to include the Big Bear Lake in-lieu exchange water as an extraction from the San Bernardino Basin Area and thereby more accurately reflect the effects of the in-lieu exchange program on storage in the basin.

Chapter VII includes a modification to Table No. 8 to allow the calculations of export past Riverside Narrows to be better understood. The modification consists of conforming the logic used to adjust such export by users within Western, as provided for in the high groundwater mitigation agreements, to match the logic used to similarly adjust export from the San Bernardino Basin Area by users other than Plaintiffs. Such adjustment has previously been made in Report of Watermaster, Volume 6, and therefore was reflected in Table No. 8. After modification the adjustment is made later in Table No. 14.

Chapter VIII includes modifications of Table No. 9 necessary to more accurately reflect the effect of extractions used outside the San Bernardino Basin Area on storage in the Basin and to account for deliveries to the Colton and Riverside Basin Areas in a manner consistent with the amendments to the Judgment approved by the Court in 1992. The modified Table No. 9A now shows the extractions from the San Bernardino Basin Area that are exported for use in the Chino, Yucaipa, San Timoteo, Oak Glen and Beaumont Basins.



Table No. 9B shows similar extractions delivered in the Colton and Riverside Basin Areas.

Chapter IX includes modifications of Table Nos. 10 through 18 generally described as follows.

- 1) Table Nos. 10 through 13 are modified to improve readability and usefulness by relocating data that was previously in footnotes to columns in Table Nos. 3A through 3D. To improve understanding, column headings in Table Nos. 10 through 13 are also modified to create consistency with Table Nos. 3A through 3D and the text of the Annual Report. In the August 1, 2014 Annual Report, Table Nos. 10A through 13A were added in order to show the Plaintiffs allowable extractions for calendar year 2014 with and without the available imported water and new conservation water.
- 2) Table Nos. 14 and 15A are modified to provide clarity and consistent logic for applying adjustments to the total new export. The modifications include a deduction from the total new export of the amount of additional water allowed to be extracted pursuant to the high groundwater mitigation program Judgment Paragraph VI(b)6 agreements. Such inclusion in Table No. 15A permitted high groundwater mitigation program related data to be removed from footnotes on Table No. 17. Similarly, the inclusion in Table No. 14 allowed the deduction to be deleted in Report of Watermaster, Volume 6. As a result, the logic for addressing the new export calculations associated with the high groundwater mitigation program is the same in both Table No. 16 and Table No. 17. Table No. 15B has been

added to account for the loss of return flow resulting from delivery of San Bernardino Basin Area extractions to the Colton and Riverside Basin Areas. Such accounting maintains hydrologic integrity in the San Bernardino Basin Area and enables Watermaster to provide San Bernardino Valley with credit in the Colton and Riverside Basin Areas for the return flow resulting from deliveries to these Basins of San Bernardino Basin Area extractions and imported water pursuant to Judgment Paragraph X as amended in 1992.

- 3) Table Nos. 16 and 17 are summary tables and have been modified primarily to express the determinations of credit or obligation in uniformly defined terms that result in data that is more accurate and more directly useable for purposes other than determining compliance with the Judgment. The determination of the net accumulated credit or obligation for Western and San Bernardino Valley is based on a summation of all activities or water transfers that affect groundwater storage in the San Bernardino Basin Area or storage in the Colton and Riverside Basin Areas which in turn can affect Base Flow at Riverside Narrows. The tables have been modified to show how the amount of each type of water transfer affects water in storage. This modification in Table No. 17 may prove useful in making comparisons between the calculation of change in groundwater storage based on the annual average yield associated with the natural safe yield determination by Watermaster and the storage change based on water level

data. Such comparison is unnecessary for determination of compliance with the Judgment.

- 4) Table Nos. 17A, 17B-1 through 17B-4 and 17C are used to account for Western imported water (17A), Plaintiffs new conservation water (17B) and Riverside Basin mitigation water (17C) in the San Bernardino Basin Area. Table No. 17A was modified and Table Nos. 17B-1 through 17B-4 were added to account for Plaintiffs new conservation water in the September 6, 2013 Annual Report. Table 17B-5 was added to account for San Bernardino Valley's new conservation water. Table No. 17C was added in the April 1, 2014 Annual Report to account for Riverside Basin mitigation related to Seven Oaks water conserved in the San Bernardino Basin Area. In this Annual Report, Table Nos. 17A and 17B-1 through 17B-4 have been modified to include an accounting for transfers of imported water pursuant to Paragraphs 5 and 11 of Judgment Paragraph VI(b)6 agreements dated August 18, 2004 and July 17, 2013 respectively.
- 5) Table No. 18 has been modified to more clearly address the four basic questions regarding compliance with four general requirements of the Judgment. The table clearly indicates: a) if Plaintiffs are in compliance with provisions of the Judgment; b) if any replenishment is required in the San Bernardino Basin Area by San Bernardino Valley and c) & d) if either Western or San Bernardino Valley may be required to provide replenishment between the Bunker Hill Dike and Riverside Narrows.

# DIAGRAM No. 1 ORGANIZATION OF ANNUAL REPORT

Sources of Data for Plaintiff Compliance in SBBA

Sources of Data for Determining Western and Valley Required Replenishment

61

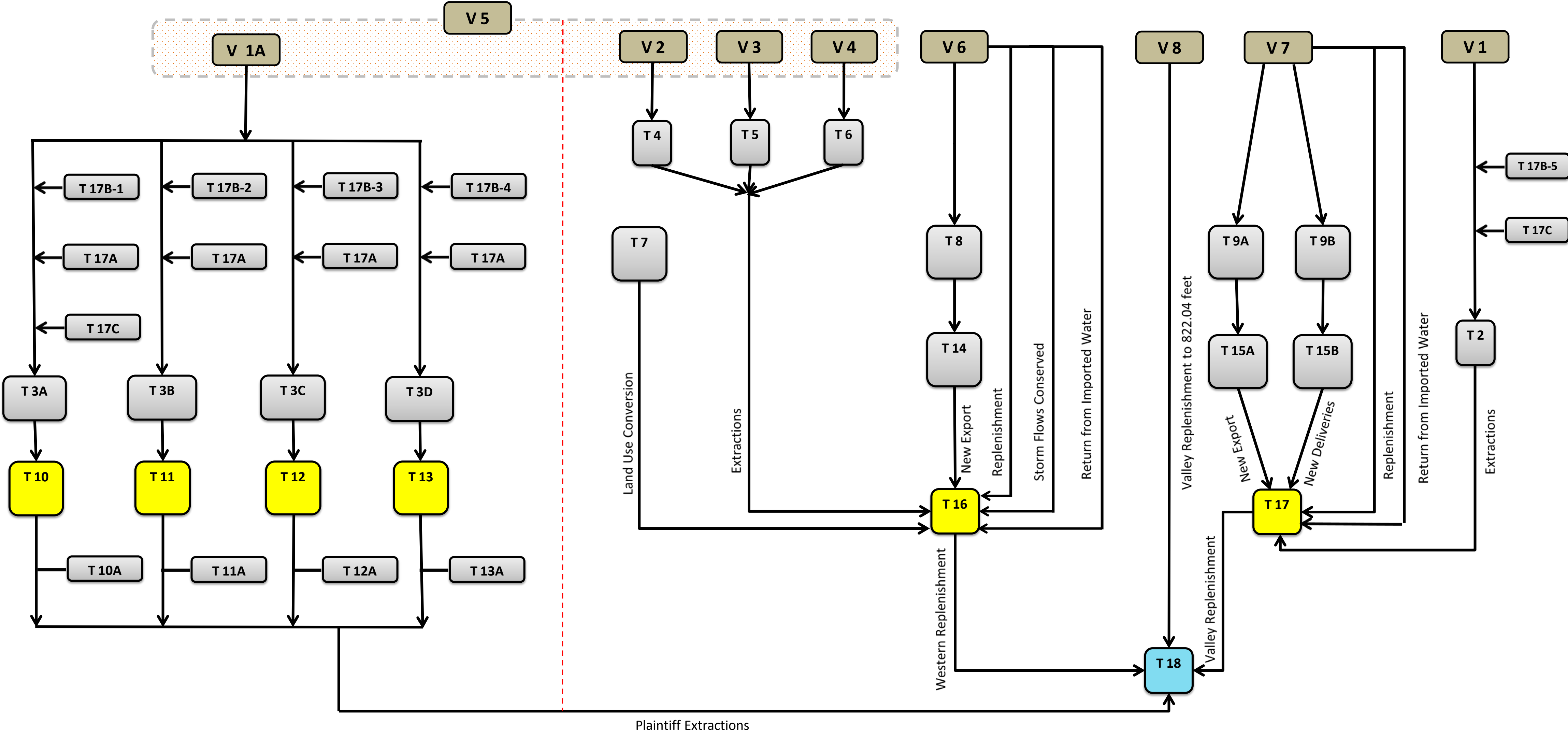

## **DIAGRAM NO. 1 INDEX**

### **REPORT OF WATERMASTER, VOLUMES 1 THROUGH 8**

- 1 Verified Extractions from the San Bernardino Basin Area by Non-Plaintiffs for Use Within San Bernardino County
- 1A Verified Extractions from the San Bernardino Basin Area by Plaintiffs
- 2 Verified Extractions from the Colton Basin Area
- 3 Verified Extractions from the Riverside Basin Area Within San Bernardino County
- 4 Verified Extractions from the Riverside Basin Area Within Riverside County
- 5 Distribution of Extractions
- 6 Verified Extractions from the San Bernardino Basin Area, Colton Basin Area, and Riverside Basin Area for Use Within Western on Lands Not Tributary to the Riverside Narrows
- 7 Verified Extractions from the San Bernardino Basin Area for Use on Lands Not Within Western Nor Tributary to the Riverside Narrows and for Use on Lands Within Colton Basin Area
- 8 Groundwater Surface Elevations of Wells Numbered 1S/4W-21Q3, 1S/4W-29H1 and 1S/4W-29Q1 Located Within the Colton Basin Area and Riverside Basin Area in San Bernardino County

### **ANNUAL REPORT TABLES 2 THROUGH 18**

- 2 Adjusted Right to Extract and Verified Extractions of Other Than Plaintiffs From the San Bernardino Basin Area
- 3A-1 Adjusted Right of City of Riverside to Extract From the San Bernardino Basin Area For Use in Each Service Area
- 3A-2 Verified Extractions by the City of Riverside From the San Bernardino Basin Area For Delivery to Each Service Area
- 3B-1 Adjusted Right of Riverside Highland Water Company to Extract From the San Bernardino Basin Area For Use in Each Service Area
- 3B-2 Verified Extractions by Riverside Highland Water Company From the San Bernardino Basin Area For Delivery to Each Service Area
- 3C-1 Adjusted Right of Agua Mansa Water Company and Meeks & Daley Water Company to Extract From the San Bernardino Basin Area For Use in Each Service Area
- 3C-2 Verified Extractions by Agua Mansa Water Company and Meeks & Daley Water Company From the San Bernardino Basin Area For Delivery to Each Service Area
- 3D-1 Adjusted Right of The Regents of the University of California to Extract From the San Bernardino Basin Area For Use in Each Service Area
- 3D-2 Verified Extractions by The Regents of the University of California From the San Bernardino Basin Area For Delivery to Each Service Area
- 4 Verified Extractions From Colton Basin Area by San Bernardino and Riverside County Entities For Use In Each County

## DIAGRAM NO. 1 INDEX

- 5 Verified Extractions from Riverside Basin Area Within San Bernardino County by San Bernardino and Riverside County Entities For Use In Each County
- 6 Verified Extractions From Riverside Basin Area Within Riverside County For Use In Riverside County
- 7 Reduction in Return Flow Contributing to Base Flow at Riverside Narrows Resulting From Conversion of Agricultural Uses of Water to Domestic Uses Connected to a Sewage System Discharging to the River Below Riverside Narrows
- 8 Verified Extractions From the San Bernardino Basin Area, the Colton Basin Area, and the Riverside Basin Area For Use Within Western on Lands That Are Not Tributary to the Riverside Narrows
- 9A Verified Extractions from the San Bernardino Basin Area For Use on Lands Not Within Western Nor Tributary to Riverside Narrows
- 9B Verified Extractions from the San Bernardino Basin Area For Use on Lands Within Colton and Riverside Basin Areas
- 10 Annual Accounting of Extractions by the City of Riverside From the San Bernardino Basin Area For Delivery to Each Service Area
- 10A Allowable Extractions by the City of Riverside From the San Bernardino Basin Area For Delivery to Each Service Area
- 11 Annual Accounting of Extractions by Riverside Highland Water Company From the San Bernardino Basin Area For Delivery to Each Service Area
- 11A Allowable Extractions by Riverside Highland Water Company From the San Bernardino Basin Area For Delivery to Each Service Area
- 12 Annual Accounting of Extractions by Agua Mansa Water Company and Meeks & Daley Water Company From the San Bernardino Basin Area For Delivery to Each Service Area
- 12A Allowable Extractions by Agua Mansa Water Company and Meeks & Daley Water Company From the San Bernardino Basin Area For Delivery to Each Service Area
- 13 Annual Accounting of Extractions by The Regents of The University of California From the San Bernardino Basin Area For Delivery to Each Service Area
- 13A Allowable Extractions by The Regents of The University of California From the San Bernardino Basin Area For Delivery to Each Service Area
- 14 Annual Accounting for Western Municipal Water District Export of Extractions From San Bernardino Basin Area, Colton Basin Area, and Riverside Basin Area for Use Within Western on Lands That Are Not Tributary to the Riverside Narrows
- 15A Annual Accounting for San Bernardino Valley Municipal Water District Export of Extractions from San Bernardino Basin Area For Use on Lands Not Within Western Nor Tributary to the Riverside Narrows

## **DIAGRAM NO. 1 INDEX**

- 15B Annual Accounting for San Bernardino Valley Municipal Water District Delivery of Extractions from San Bernardino Basin Area For Use on Lands Within Colton and Riverside Basin Areas
- 16 Annual Accounting for Western Extractions From Colton Basin Area and Riverside Basin Area within Riverside and San Bernardino Counties for Use Outside San Bernardino Valley
- 17 Annual Accounting for San Bernardino Valley Municipal Water District Extractions From San Bernardino Basin Area
- 17A Annual Accounting for Additional Extractions of Imported Water From San Bernardino Basin Area by Western Municipal Water District
- 17B-1 Annual Accounting for Additional Extractions of New Conservation Water and Imported Water From San Bernardino Basin Area by City of Riverside
- 17B-2 Annual Accounting for Additional Extractions of New Conservation Water and Imported Water From San Bernardino Basin Area by Riverside Highland Water Company
- 17B-3 Annual Accounting for Additional Extractions of New Conservation Water and Imported Water From San Bernardino Basin Area by Aqua Mansa Water Company and Meeks & Daley Water Company
- 17B-4 Annual Accounting for Additional Extractions of New Conservation Water and Imported Water From San Bernardino Basin Area by The Regents of The University of California
- 17B-5 Annual Accounting for Additional Extractions of New Conservation Water From San Bernardino Basin Area by Entities in San Bernardino County Other Than Plaintiffs
- 17C Annual Accounting for Riverside Basin Mitigation Account Related to Seven Oaks Water Conserved in San Bernardino Basin Area
- 18 Summary of Compliance with Four Principal Provisions of the Judgment

**TABLE NO. 1**  
**COSTS TO THE PARTIES FOR USGS**  
**SURFACE WATER MEASUREMENTS USED BY**  
**WESTERN-SAN BERNARDINO WATERMASTER**

November 1, 2013 to October 31, 2014

	<u>Parties</u> <u>Share</u> <u>of Cost</u>	<u>USGS</u> <u>Share</u> <u>of Cost</u>
Santa Ana River near Mentone	\$13,550	\$6,850
Santa Ana River near Mentone Supplemental	\$8,150	\$4,100
Mill Creek near Mentone	14,550	0
Plunge Creek near Highland Upper Division	0	0
Plunge Creek near Highland Middle Diversion	0	0
Plunge Creek near Highland Streamflow	13,550	6,850
City Creek Canal near Highland	8,150	4,100
City Creek near Highland Streamflow	13,550	6,850
San Timoteo Creek near Loma Linda	13,550	6,850
East Twin Creek near Arrowhead Springs	13,550	6,850
Waterman Canyon Creek near Arrowhead Springs	13,550	6,850
Santa Ana River at E Street	14,500	0
Warm Creek near San Bernardino	13,550	6,850
<u>Lytle Creek at Fontana Union Water Company Head Gates</u>		
Infiltration Pipeline Meter	3,150	1,600
Lytle Creek near Fontana Streamflow	22,600	0
FY 2013 Credit	(13,550)	(6,850)
Extra Measurements	2,000	0
Weir No. 2 and No. 3 — Head Gate Diversion	13,550	0
20-ft. Weir — Forebay Spillway Return to Creek	13,550	0
<u>Southern California Edison Lower Powerhouse on Lytle Creek</u>		
20-ft. Weir — Discharge of Lower Powerhouse	13,550	0
Parshall Flume — Return to Creek from Afterbay	13,550	0
20-ft. Weir to West Fontana Union Diversion	13,550	0
Cajon Creek below Lone Pine Creek near Keenbrook	13,550	6,850
Devil Canyon Creek near San Bernardino	13,550	6,850
Lytle Creek at Colton	<u>13,550</u>	<u>6,850</u>
 SUBTOTAL FOR PARTIES	 \$262,800	
 SUBTOTAL FOR UNITED STATES GEOLOGICAL SURVEY		 <u><u>\$71,450</u></u>
 TOTAL COST FOR SURFACE WATER MEASUREMENTS		 \$334,250



**CHAPTER III**

**EXTRACTIONS FROM THE  
SAN BERNARDINO BASIN AREA**

## **CHAPTER III**

### **EXTRACTIONS FROM THE SAN BERNARDINO BASIN AREA**

The extractions from the San Bernardino Basin Area have been classified as first, those extractions and diversions for use by other than Plaintiffs and second, those extractions and diversions for use by Plaintiffs.

The total verified extractions by other than Plaintiffs for calendar years 1971 through 2013, together with five-year totals, are shown on Table No. 2. The individual work sheets for the 2013 verifications are included in Report of Watermaster, Volume 1-2013.

The total verified extractions from the San Bernardino Basin Area by Plaintiffs for the calendar years 1971 through 2013, are shown on Table No. 3. The individual work sheets for the 2013 verifications and distribution of extractions by Plaintiffs are included in Report of Watermaster, Volume 1A-2013 and Volume 5-2013.

For reference, the Adjusted Rights of other than Plaintiffs and Plaintiffs are also shown on Table Nos. 2 and 3. Commencing in 2013, the Adjusted Rights include part of the new conservation resulting from operation of Seven Oaks Reservoir pursuant to Judgment Paragraphs VI(b) and VI(c). The part included consists of the average annual new conservation that is forecast to occur over a long term at the existing or enhanced Santa Ana River Spreading Grounds. Table Nos. 2 and 3 show the Adjusted Right as the sum of the Safe Yield Adjusted Right and the New Conservation Allocation resulting from the long term forecast commencing in 2013.

Table Nos. 2 and 3 also show that extractions are equal to the total extractions minus any additional extractions which are allowed pursuant to

Judgment Paragraph VI(b)6 agreements. Additional extractions have been allowed in the past to mitigate high groundwater conditions and to allow extraction by Plaintiffs of imported water recharged by Western pursuant to a Judgment Paragraph VI(b)6 agreement. In the future, any new conservation resulting from operation of Seven Oaks Reservoir that is not recharged at the existing or enhanced Santa Ana River Spreading Grounds may be made available to users through Judgment Paragraph VI(b)6 agreements and similarly accounted for in Table Nos. 2 and 3 as additional extractions.

Paragraph VII of the Judgment titled *Water Discharged Across Bunker Hill Dike* recites as follows:

*“San Bernardino Valley shall keep in force an agreement with the City of San Bernardino that the present annual quantity of municipal sewage effluent discharged across Bunker Hill Dike, assumed for all purposes herein to be 16,000 acre-feet annually, shall be committed to the discharge of the downstream obligations imposed on San Bernardino Valley under this Judgment or under the Orange County Judgment, and that such effluent shall comply with the requirements of the Santa Ana River Basin Regional Water Quality Control Board in effect December 31, 1968.”*

The Judgment does not charge the Watermaster with verification of the 16,000 acre-feet amount of sewage effluent discharge or the enforcement of the water quality requirements.

Prior to December 1972, sewage effluent was discharged across the Bunker Hill Dike via Warm Creek (Plant No. 1) and the Santa Ana River (Plant No. 2). With the completion of the new Water Quality Control Plant at the "E" Street site (Plant No. 2) the total effluent discharge of the City of San Bernardino Water Quality Control Plant accrued to the Santa Ana River immediately upstream from the "E" Street Bridge. In January 1973, the Watermaster in cooperation with the USGS began operation of a gaging station on the plant outfall to obtain a continuous record of the quantity and mineral quality of the sewage effluent discharged to the Santa Ana River. This station

has been discontinued and Watermaster now relies on the City of San Bernardino for these data.

On April 1, 1996, the cities of San Bernardino and Colton began discharging their municipal wastewater effluent at a point several miles farther downstream from the historical discharge points, through the Rapid Infiltration and Extraction System (RIX). RIX is a 50-acre groundwater recharge and extraction system specifically designed to meet the filtration and disinfection requirements of *California Code of Regulations, Title 22*, for discharge in Reach Four of the Santa Ana River.

The Regional Water Quality Control Board had ordered the two cities to provide Title 22 treatment levels of their discharge prior to its entrance into the Santa Ana River. An evaluation indicated that a system for groundwater recharge and immediate extraction would accomplish the required treatment levels and would be more cost effective than a conventional tertiary treatment system at the existing plant sites. The RIX system is located adjacent to the Santa Ana River in the Riverside Basin Area in San Bernardino County. The project was constructed by the two cities with the Santa Ana Watershed Project Authority acting as the construction manager.

In order to ensure that the secondary effluent recharged to the groundwater system would be fully treated and recovered, it was determined that the amount of RIX extractions should exceed the amount of recharged water. The over-extraction, combined with the fact that the RIX discharge point is located several miles downstream from the prior discharge points of the two cities, had an immediate impact upon the flows at both Riverside Narrows and Prado. The effect of the changed points of discharge on the key wells (see Chapter V, Minimum Water Surface Elevations) is being monitored closely with monthly depth to water readings at the wells.

The discharge to the Santa Ana River from the Cities of San Bernardino and Colton has been determined by the Watermaster as shown on the following table:

Calendar Year	Plant No. 1 (Acre-Feet)	Plant No. 2 (Acre-Feet)	Total (Acre-Feet)	RIX (Acre-Feet) San Bernardino and Colton combined flows
1971	5,705	8,925	14,630	
1972	6,784	9,963	16,747	
1973	-	17,640	17,640	
1974	-	17,070	17,070	
1975	-	16,820	16,820	
1976	-	17,530	17,530	
1977	-	17,720	17,720	
1978	-	18,690	18,690	
1979	-	19,350	19,350	
1980	-	20,670	20,670	
1981	-	21,120	21,120	
1982	-	24,493	24,493	
1983	-	23,170	23,170	
1984	-	21,759	21,759	
1985	-	23,814	23,814	
1986	-	25,442	25,442	
1987	-	27,154	27,154	
1988	-	27,290	27,290	
1989	-	28,300	28,300	
1990	-	27,770	27,770	
1991	-	26,980	26,980	
1992	-	25,510	25,510	
1993	-	24,660	24,660	
1994	-	24,790	24,790	
1995	-	26,260	26,260	
1996	-	6,610	6,610	30,880
1997	-	0	0	44,950
1998	-	0	0	48,710
1999	-	0	0	48,040
2000	-	0	0	47,230
2001	-	0	0	47,250
2002	-	0	0	43,828
2003	-	242 <sup>1</sup>	242	45,713
2004	-	286 <sup>1</sup>	286	44,501
2005	-	4,249 <sup>1</sup>	4,249	42,267 <sup>2</sup>
2006	-	1,155 <sup>1</sup>	1,155	44,979 <sup>2</sup>
2007	-	75 <sup>1,2</sup>	75	43,153
2008	-	568 <sup>1,2</sup>	568	42,140
2009	-	217 <sup>1,2</sup>	217	40,634
2010	-	755 <sup>1</sup>	755	40,157
2011	-	766 <sup>1</sup>	766	39,057
2012	-	76 <sup>1</sup>	76	37,326
2013	-	44 <sup>1</sup>	44	35,022
2014	-	-	-	-
2015	-	-	-	-

<sup>1</sup> Direct discharge of treated wastewater flows to SAR when the SAR flow rate at "E" Street Gage is adequate to provide 20:1 dilution.

<sup>2</sup> Amount corrected during a subsequent year verification of extractions.

**2013 and 2014 Annual Report Modifications  
Table Nos. 2 and 3**

In 2012, Western and San Bernardino Valley contracted with GEOSCIENCE Support Services and SAIC (GEOSCIENCE/SAIC) to:

- 1) Calculate the amount of new conservation resulting from the operation of Seven Oaks Reservoir from 1998 through 2012.
- 2) Forecast the long term average annual amounts of Seven Oaks related new conservation likely to occur at the downstream spreading grounds under each of the following assumed conditions:
  - a. Current delivery and recharge capability of 195 cfs
  - b. Expanded delivery and recharge capability of 300 cfs, and
  - c. Expanded delivery and recharge capability of 500 cfs.
- 3) Allocate the new conservation among the Plaintiffs and San Bernardino Valley in proportion to their respective share of the natural safe yield.

The results of the GEOSCIENCE/SAIC work is summarized as follows:

Party	New Conservation Allocation			
	Amount for Prior Years 1998-2012 AF	Forecast Amounts for 195 cfs Diversion AF/yr	Forecast Amounts for 300 cfs Diversion AF/yr	Forecast Amounts for 500 cfs Diversion AF/yr
City of Riverside	9,635	1,719	2,235	2,431
Riverside Highland Water Co.	793	141	184	200
Meeks and Daley Water Co.	1,448	258	336	365
University of California	98	18	23	25
San Bernardino Valley	30,866	5,507	7,161	7,787
<b>Total</b>	<b>42,840</b>	<b>7,643</b>	<b>9,939</b>	<b>10,807</b>

Forecasts for diversion of 300 cfs and 500 cfs are based on planned enhancement of the delivery and recharge facilities. Construction of these

facilities has not been completed. Therefore, the new conservation allocations included in the Adjusted Right commencing in calendar year 2013 are the amounts forecast to result from the current diversion capacity of 195 cfs. At the time enhanced recharge facilities become operational, the Watermaster will consider increasing the new conservation allocation, thereby further increasing the Adjusted Right for users other than Plaintiffs in Table No. 2 and Plaintiffs in Table Nos. 3A-1 through 3D-1.

New conservation related to operation of Seven Oaks Reservoir will be made available for extraction by Plaintiffs and users in San Bernardino Valley through different mechanisms for each of three components of the new conservation. The component resulting from recharge at the Santa Ana River Spreading Grounds is made available through a further adjustment of the Adjusted Right as provided in Judgment Paragraphs VI(b) and VI(c). The components resulting from determination of prior years (1998-2012) new conservation and future new conservation resulting from direct use or recharge at locations other than the Santa Ana River Spreading Grounds will likely be made available through the existing and future Judgment Paragraph VI(b)6 agreements. The future VI(b)6 agreements will likely be entered following any major hydrologic event (wet year) that results in conservation at locations other than the Santa Ana River Spreading Grounds provided the capability of the Spreading Grounds was exceeded.

The specific mechanisms that will be used to account for all three components of new conservation as well as other types of additional water made available pursuant to existing or future Judgment Paragraph VI(b)6 agreements are as follows.

- 1) A mechanism to increase the Adjusted Right of Plaintiffs and San Bernardino Valley to reflect the amounts of new

conservation forecast to result from long term operation of Seven Oaks Reservoir and diversion of increased amounts, relative to amounts diverted using safe yield practices, for recharge at the downstream spreading grounds. (See the second, third, and fourth data columns in the table above) This increase in Adjusted Right is pursuant to Judgment Paragraphs VI(b) and VI(c). (New Conservation)

- 2) A mechanism to make available to Plaintiffs and San Bernardino Valley, when needed to offset excess extractions, the amount of allocated new conservation determined by Watermaster to have resulted from operation of Seven Oaks Reservoir from 1998 through 2012. (See the first data column in the table above) Such amounts are made available through the 2013 additional extractions agreement entered by Western and San Bernardino Valley pursuant to Judgment Paragraph VI(b)6 and approved by the Court on November 19, 2013. (New Conservation)
- 3) A mechanism to make available to Plaintiffs and San Bernardino Valley, when needed to offset excess extractions, the amount of allocated new conservation determined by Watermaster to have resulted from a future major hydrologic event that resulted in direct use of Seven Oaks water or recharge of the San Bernardino Basin Area with Seven Oaks water in areas other than the Santa Ana River Spreading Grounds provided the capability to recharge at the Spreading Grounds has been fully utilized. Such wet year hydrologic events are forecast to occur in the future on average



in one out of five years. The long term average annual amount of new conservation that could result from such events is forecast to be about 10,000 acre-feet per year. The specific amounts of new conservation will be set forth in Judgment Paragraph VI(b)6 agreements that will allow additional extractions. (New Conservation)

- 4) A mechanism to account for the additional extractions that occurred between 1981 and 2004 for the purpose of mitigating the high groundwater condition. Such additional extractions were made pursuant to numerous Judgment Paragraph VI(b)6 agreements and were previously accounted for in footnotes on Table Nos. 2, 10 through 13 and 17. (High Groundwater Mitigation)
- 5) A mechanism to account for extractions of water pursuant to the 2004 replenishment and extraction agreement that allows Western or Plaintiffs to extract recharged imported water. (Western's Extraction of Imported Water)
- 6) A mechanism to account for Plaintiffs transfer to Western of an amount of water equal to all or a part of Plaintiffs unused water right in the San Bernardino Basin Area, subject to the provisions of Paragraph 11 of the 2013 agreement referenced in (2) above.

The second additional water accounting mechanism described above provides a means of offsetting excess extractions using new conservation water determined by Watermaster to have resulted from operation of Seven Oaks Reservoir from 1998 through 2012 as provided in the 2013 Judgment Paragraph VI(b)6 agreement. In 2013 the Total Extractions for entities in San Bernardino

County other than Plaintiffs for the period 2009 through 2013 were greater than San Bernardino Valley's Adjusted Right by 17,815 acre-feet. Table No. 2, page 1b of 2 (Footnote 19) shows the use of 17,815 acre-feet of Additional Extractions to reduce the Extractions amount to 145,601 acre-feet thereby causing the Five Year Extractions for 2009 through 2013 to equal the Five Year Adjusted Right on Table No. 2, page 2b of 2. Table No. 17B-5 (Footnotes 2 and b) shows the New Conservation Additional Extractions in the amount of 17,815 acre-feet and an equal reduction in San Bernardino Valley's New Conservation Net Accumulated (Credit) from 30,866 acre-feet to 13,051 acre-feet.

Paragraph 10 of the 2013 agreement referenced in the second mechanism described above also provides that any amount of replenishment in the San Bernardino Basin Area resulting from the 1998 through 2012 operation of Seven Oaks Reservoir and related diversion and spreading facilities that, in the absence of such operation, would have been replenished in the Riverside Basin, shall not be considered new conservation and shall not be allocated for use by Plaintiffs and users within San Bernardino Valley and shall instead be included in a Riverside Basin Mitigation Account. The agreement further provides that the City of Riverside may be required to increase extractions from its wells in the San Bernardino Basin Area and reduce extractions in its Flume Tract wells in the Riverside Basin by the same amount. Such change in location of extractions effectively transfers to the Riverside Basin, water that is conserved in the San Bernardino Basin Area through Seven Oaks related operations that would otherwise have been conserved in the Riverside Basin. Such transfers mitigate the adverse effects of Seven Oaks new conservation and reduce the amount in the Riverside Basin Mitigation Account. The amount in the Riverside Basin Mitigation Account may also be reduced by extraction of water from the

San Bernardino Basin Area by producers other than Plaintiffs that is subsequently recharged in the Riverside Basin.

The GEOSCIENCE/SAIC work referenced previously resulted in a determination of the following amounts of conserved water that should be included in the Riverside Basin Mitigation Account:

- 1) An initial amount of 2,713 acre-feet resulting from Seven Oaks related conservation operations in prior years 1998 through 2012.
- 2) An annual amount of 483 acre-feet/year, commencing in 2013, resulting from Seven Oaks related conservation operations based on the current diversion capacity of 195 cfs.

The accounting for amounts included in the Riverside Basin Mitigation Account and the amounts extracted in-lieu of Riverside Basin extractions and for Riverside Basin recharge is shown on Table 17C. The amounts extracted are included in Table Nos. 2 and/or 3A-2 as Additional Extractions. Additional extractions are excluded from determination of Plaintiff's compliance with the Judgment and the determination of San Bernardino Valley replenishment obligations in the San Bernardino Basin Area.

The sixth mechanism described above also references the 2013 Judgment Paragraph VI(b)6 agreement. Paragraph 11 of the 2013 agreement provides that commencing in 2013 Plaintiffs may transfer to Western an amount of water equal to all or a part of Plaintiffs unused water right in the San Bernardino Basin Area provided the amount of such transfer, plus any remaining balance of such water transferred previously, may not exceed the Plaintiffs aggregate amount of previously transferred right to extract imported water pursuant to Paragraph 5 of the 2004 Judgment Paragraph VI(b)6 agreement.

Paragraph 11 was included in the 2013 agreement in partial response to an agreement dated March 20, 2007 among Western, San Bernardino Valley and the City of Riverside wherein the parties agreed to use their best efforts to implement an accounting methodology that would allow Plaintiffs to fully utilize their water rights in the San Bernardino Basin Area. Paragraph 11 essentially establishes a “buffer” for each Plaintiff equal to the amount of previously transferred right to extract imported water (see fifth mechanism above). Plaintiffs may transfer unused water right or under extractions into the “buffer” and also use the “buffer” to address excess extractions thereby making greater utilization of Plaintiffs water right than would otherwise be possible. Since the “buffer” results only from transfers of imported water, the storage of native water or safe yield is not adversely affected.

This Annual Report includes modifications to Table Nos. 17B-1 through 17B-4 and 17A to account for the transfers resulting from implementation of Paragraph 11. Tables Nos. 17B-1 through 17B-4 were originally designed to account for new conservation water allocated to each Plaintiff by Watermaster. These tables have been expanded to include an accounting for the imported water transfers associated with implementation of Paragraph 11 of the 2013 Agreement. Therefore, in addition to showing the remaining balance of new conservation water allocations, the table shows the imported water net accumulated balance or “buffer” balance at the end of each year. The table is designed to ensure that the imported water balance does not exceed the total amount of right to extract imported water transferred from Western to a Plaintiff pursuant to the 2004 Judgment Paragraph VI(b)6 agreement.

Table No. 17A was modified in this Annual Report to function as a repository for the Plaintiffs “buffer” water. So, in addition to accounting for the acquisition and extractions of imported water, the table also accounts for the sum

of all “buffer” transfers by Plaintiffs and shows the Plaintiff imported water net accumulated balance at the end of each year.

In addition to changes needed to address new conservation and Plaintiff transfers of imported water, Table Nos. 2 and 3 were also modified to improve the readability of the report and improve the accuracy of the extraction data. Annual reports prior to calendar year 2012 accounted for additional extractions (mainly high groundwater) through numerous footnotes with data in Table Nos. 2, 10 through 13 and 17. By adding a column titled Additional Extractions in Table Nos. 2 and 3, the data in these footnotes were eliminated and the report is more easily read and understood.

The data in Table No. 2 is more accurate as a result of a correction in Report of Watermaster, Volume 1, which is the source of verified extractions by users other than Plaintiffs. Report of Watermaster, Volume 1 was modified to include the Big Bear Lake in-lieu exchange water, which is provided by San Bernardino Valley from its State Water Project supply, as an extraction from the San Bernardino Basin Area and thereby more accurately reflect the effects of the in-lieu exchange program on storage in the Basin.

ADJUSTED RIGHT TO EXTRACT AND VERIFIED EXTRACTIONS OF  
OTHER THAN PLAINTIFFS  
FROM THE SAN BERNARDINO BASIN AREA  
ANNUAL TOTALS  
(All Values in Acre-Feet)

Calendar Year	Adjusted Right			Extractions		
	Safe Yield Adjusted Right <i>1</i>	New Conservation Allocation <i>2</i>	Adjusted Right <i>3</i>	Total Extractions	Additional Extractions	Extractions
1971	171,342		171,342	163,186		163,186
1972	167,238		167,238	167,227		167,227
1973	167,238		167,238	159,781		159,781
1974	167,238		167,238	158,685		158,685
1975	167,238		167,238	151,681		151,681
1976	167,238		167,238	144,317		144,317
1977	167,238		167,238	144,811		144,811
1978	167,238		167,238	137,040		137,040
1979	167,238		167,238	154,807		154,807
1980	167,238		167,238	159,422		159,422
1981	167,238		167,238	173,311		173,311
1982	167,238		167,238	153,096		153,096
1983	167,238		167,238	146,434		146,434
1984	167,238		167,238	181,801		181,801
1985	167,238		167,238	180,913	13,675 <i>4</i>	167,238
1986	167,238		167,238	184,924		184,924
1987	167,238		167,238	177,263	10,025 <i>5</i>	167,238
1988	167,238		167,238	186,857	19,619 <i>6</i>	167,238
1989	167,238		167,238	182,085		182,085
1990	167,238		167,238	174,994		174,994
1991	167,238		167,238	166,498		166,498
1992	167,238		167,238	172,913	5,675 <i>7</i>	167,238
1993	167,238		167,238	178,372	11,134 <i>8</i>	167,238
1994	167,238		167,238	187,507	18,013 <i>9</i>	169,494
1995	167,238		167,238	182,171	14,933 <i>10</i>	167,238
1996	167,238		167,238	193,446	18,013 <i>11</i>	175,433
1997	167,238		167,238	195,284	18,013 <i>12</i>	177,271
1998	167,238		167,238	198,857	18,013 <i>13</i>	180,844
1999	167,238		167,238	207,709	40,471 <i>14</i>	167,238
2000	167,238		167,238	201,111	25,778 <i>15</i>	175,333

ADJUSTED RIGHT TO EXTRACT AND VERIFIED EXTRACTATIONS OF  
OTHER THAN PLAINTIFFS  
FROM THE SAN BERNARDINO BASIN AREA  
ANNUAL TOTALS  
(All Values in Acre-Feet)

Calendar Year	Adjusted Right			Extractions			
	Safe Yield Adjusted Right <i>1</i>	New Conservation Allocation <i>2</i>	Adjusted Right <i>3</i>	Total Extractions	Additional Extractions	Extractions	
2001	167,238		167,238	191,573	24,335	<i>16</i>	167,238
2002	167,238		167,238	186,543	19,305	<i>17</i>	167,238
2003	167,238		167,238	171,017			171,017
2004	167,238		167,238	180,960	13,722	<i>18</i>	167,238
2005	167,238		167,238	191,425			191,425
2006	167,238		167,238	209,393			209,393
2007	167,238		167,238	199,366			199,366
2008	167,238		167,238	196,170			196,170
2009	167,238		167,238	179,077			179,077
2010	167,238		167,238	166,274			166,274
2011	167,238		167,238	173,544			173,544
2012	167,238		167,238	177,201			177,201
2013	167,238	5,507	172,745	163,416	17,815	<i>19</i>	145,601
2014	167,238	5,507	172,745				
2015	167,238	5,507	172,745				
2016	167,238	5,507	172,745				
2017	167,238	5,507	172,745				
2018	167,238	5,507	172,745				
2019	167,238	5,507	172,745				
2020	167,238	5,507	172,745				

*Note: Total Extractions - See Report of Watermaster, Volume 1, Table 8, Total Non-Plaintiff Extractions from San Bernardino Basin Area Excluding Minor Production*

*1 Adjusted Right not effective until January 1, 1972; therefore, 1971 Base Right is as verified for five-year Base Period 1959-63*

*2 New Conservation Allocation takes effect in the first year shown and continues until further adjusted by Watermaster.*

*Pursuant to Paragraph VI(c) of the Judgment, Watermaster has determined the other than Plaintiffs New Conservation Allocation to be 5,507 acre-feet per year starting in 2013. The 2013 Paragraph VI(b)6 Agreement provides that Watermaster will periodically consider changing this number based on provisions of the Agreement.*

*3 Adjusted Right equals Safe Yield Adjusted Right plus New Conservation Allocation.*

*4 Amount deducted under February 25, 1985 and August 21, 1985 Judgment Paragraph VI(b)6 Agreement. (High Groundwater Mitigation)*

ADJUSTED RIGHT TO EXTRACT AND VERIFIED EXTRACTIONS OF  
OTHER THAN PLAINTIFFS  
FROM THE SAN BERNARDINO BASIN AREA

5 Amount deducted under May 20, 1987 2nd Amendment to December 22, 1981 Judgment VI(b)6 Agreement  
(hereinafter "December 22, 1981 Agreement"). (High Groundwater Mitigation)

6 Amount deducted under January 20, 1988 3rd Amendment to December 22, 1981 Agreement. (High Groundwater Mitigation)

7 Amount deducted under May 4, 1992 5th Amendment to December 22, 1981 Agreement. (High Groundwater Mitigation)

8 Amount deducted under June 16, 1993 6th Amendment to December 22, 1981 Agreement. (High Groundwater Mitigation)

9 Amount deducted under March 3, 1994 7th Amendment to December 22, 1981 Agreement. (High Groundwater Mitigation)

10 Amount deducted under March 15, 1995 8th Amendment to December 22, 1981 Agreement. (High Groundwater Mitigation)

11 Amount deducted under March 6, 1996 9th Amendment to December 22, 1981 Agreement. (High Groundwater Mitigation)

12 Amount deducted under February 19, 1997 10th Amendment to December 22, 1981 Agreement. (High Groundwater Mitigation)

13 Amount deducted under February 18, 1998 11th Amendment to December 22, 1981 Agreement. (High Groundwater Mitigation)

14 Amount deducted under January 19, 1999 13th Amendment to December 22, 1981 Agreement. (High Groundwater Mitigation)

15 Amount deducted under August 16, 2000 15th Amendment to December 22, 1981 Agreement. (High Groundwater Mitigation)

16 Amount deducted under February 7, 2001 17th Amendment to December 22, 1981 Agreement. (High Groundwater Mitigation)

17 Amount deducted under February 6, 2002 19th Amendment to December 22, 1981 Agreement. (High Groundwater Mitigation)

18 Amount deducted under August 18, 2004 21st Amendment to December 22, 1981 Agreement. (High Groundwater Mitigation)

19 Amount deducted pursuant to Paragraph 4 of the July 17, 2013 Judgment Paragraph VI(b)6 agreement, see Table No. 17B-5,  
Footnotes 2 and b.



ADJUSTED RIGHT TO EXTRACT AND VERIFIED EXTRACTIONS OF  
OTHER THAN PLAINTIFFS  
FROM THE SAN BERNARDINO BASIN AREA  
FIVE-YEAR TOTALS  
(All Values in Acre-Feet)

Five-Year Period	Five-Year Adjusted Right	Five-Year Extractions
1971-75	840,294	800,560
1972-76	836,190	781,691
1973-77	836,190	759,275
1974-78	836,190	736,534
1975-79	836,190	732,656
1976-80	836,190	740,397
1977-81	836,190	769,391
1978-82	836,190	777,676
1979-83	836,190	787,070
1980-84	836,190	814,064
1981-85	836,190	821,880
1982-86	836,190	833,493
1983-87	836,190	847,635
1984-88	836,190	868,439
1985-89	836,190	868,723
1986-90	836,190	876,479
1987-91	836,190	858,053
1988-92	836,190	858,053
1989-93	836,190	858,053
1990-94	836,190	845,462
1991-95	836,190	837,706
1992-96	836,190	846,641
1993-97	836,190	856,674
1994-98	836,190	870,280
1995-99	836,190	868,024
1996-00	836,190	876,119
1997-01	836,190	867,924
1998-02	836,190	857,891
1999-03	836,190	848,064
2000-04	836,190	848,064

ADJUSTED RIGHT TO EXTRACT AND VERIFIED EXTRACTIONS OF  
OTHER THAN PLAINTIFFS  
FROM THE SAN BERNARDINO BASIN AREA  
FIVE-YEAR TOTALS  
(All Values in Acre-Feet)

Five-Year Period	Five-Year Adjusted Right	Five-Year Extractions
2001-05	836,190	864,156
2002-06	836,190	906,311
2003-07	836,190	938,439
2004-08	836,190	963,592
2005-09	836,190	975,431
2006-10	836,190	950,280
2007-11	836,190	914,431
2008-12	836,190	892,266
2009-13	841,697	841,697
2010-14	847,204	
2011-15	852,711	
2012-16	858,218	
2013-17	863,725	
2014-18	863,725	
2015-19	863,725	
2016-20	863,725	

*Note: 5-year totals corrected to reflect any corrections on Table 2, Page 1a of 2 and Page 1b of 2.*

ADJUSTED RIGHT OF  
CITY OF RIVERSIDE  
TO EXTRACT FROM THE SAN BERNARDINO BASIN AREA  
FOR USE IN EACH SERVICE AREA  
(Including those rights acquired as successor to the  
Riverside Water Company and Gage Canal Company)  
(All Values in Acre-Feet)

Calendar Year	San Bernardino Basin Area Adjusted Right			For Use In San Bernardino Basin Area	For Use In Colton Basin Area and Riverside Basin Area in San Bernardino County	For Use In Areas Outside San Bernardino Valley		
	Safe Yield	New	Adjusted Right 3	Adjusted Right 4	Adjusted Right 4	Safe Yield	New	Adjusted Right 3
	Adjusted Right 1	Conservation Allocation 2				Adjusted Right 1	Conservation Allocation 2	
1971	53,448		53,448	1,462	1,260	50,726		50,726
1972	52,199		52,199	1,427	1,230	49,542		49,542
1973	52,199		52,199	1,427	1,230	49,542		49,542
1974	52,199		52,199	1,427	1,230	49,542		49,542
1975	52,199		52,199	1,427	1,230	49,542		49,542
1976	52,199		52,199	1,427	1,230	49,542		49,542
1977	52,199		52,199	1,427	1,230	49,542		49,542
1978	52,199		52,199	1,427	1,230	49,542		49,542
1979	52,199		52,199	1,427	1,230	49,542		49,542
1980	52,199		52,199	1,427	1,230	49,542		49,542
1981	52,199		52,199	1,427	1,230	49,542		49,542
1982	52,199		52,199	1,427	1,230	49,542		49,542
1983	52,199		52,199	1,427	1,230	49,542		49,542
1984	52,199		52,199	1,427	1,230	49,542		49,542
1985	52,199		52,199	1,427	1,230	49,542		49,542
1986	52,199		52,199	1,427	1,230	49,542		49,542
1987	52,199		52,199	1,427	1,230	49,542		49,542
1988	52,199		52,199	1,427	1,230	49,542		49,542
1989	52,199		52,199	1,427	1,230	49,542		49,542
1990	52,199		52,199	1,427	1,230	49,542		49,542
1991	52,199		52,199	1,427	1,230	49,542		49,542
1992	52,199		52,199	1,427	1,230	49,542		49,542
1993	52,199		52,199	1,427	1,230	49,542		49,542
1994	52,199		52,199	1,427	1,230	49,542		49,542
1995	52,199		52,199	1,427	1,230	49,542		49,542

ADJUSTED RIGHT OF  
CITY OF RIVERSIDE  
TO EXTRACT FROM THE SAN BERNARDINO BASIN AREA  
FOR USE IN EACH SERVICE AREA  
(Including those rights acquired as successor to the  
Riverside Water Company and Gage Canal Company)  
(All Values in Acre-Feet)

Calendar Year	San Bernardino Basin Area Adjusted Right			For Use In San Bernardino Basin Area	For Use In Colton Basin Area and Riverside Basin Area in San Bernardino County	For Use In Areas Outside San Bernardino Valley		
	Safe Yield	New		Adjusted Right 4	Adjusted Right 4	Safe Yield	New	
	Adjusted Right 1	Conservation Allocation 2	Adjusted Right 3			Adjusted Right 1	Conservation Allocation 2	Adjusted Right 3
1996	52,199		52,199	1,427	1,230	49,542		49,542
1997	52,199		52,199	1,427	1,230	49,542		49,542
1998	52,199		52,199	1,427	1,230	49,542		49,542
1999	52,199		52,199	1,427	1,230	49,542		49,542
2000	52,199		52,199	1,427	1,230	49,542		49,542
2001	52,199		52,199	1,427	1,230	49,542		49,542
2002	52,199		52,199	1,427	1,230	49,542		49,542
2003	52,199		52,199	1,427	1,230	49,542		49,542
2004	52,199		52,199	1,427	1,230	49,542		49,542
2005	52,199		52,199	1,427	1,230	49,542		49,542
2006	52,199		52,199	1,427	1,230	49,542		49,542
2007	52,199		52,199	1,427	1,230	49,542		49,542
2008	52,199		52,199	1,427	1,230	49,542		49,542
2009	52,199		52,199	1,427	1,230	49,542		49,542
2010	52,199		52,199	1,427	1,230	49,542		49,542
2011	52,199		52,199	1,427	1,230	49,542		49,542
2012	52,199		52,199	1,427	1,230	49,542		49,542
2013	52,199	1,719	53,918	1,427	1,230	49,542	1,719	51,261
2014	52,199	1,719	53,918	1,427	1,230	49,542	1,719	51,261
2015	52,199	1,719	53,918	1,427	1,230	49,542	1,719	51,261
2016	52,199	1,719	53,918	1,427	1,230	49,542	1,719	51,261
2017	52,199	1,719	53,918	1,427	1,230	49,542	1,719	51,261
2018	52,199	1,719	53,918	1,427	1,230	49,542	1,719	51,261
2019	52,199	1,719	53,918	1,427	1,230	49,542	1,719	51,261
2020	52,199	1,719	53,918	1,427	1,230	49,542	1,719	51,261

ADJUSTED RIGHT OF  
CITY OF RIVERSIDE  
TO EXTRACT FROM THE SAN BERNARDINO BASIN AREA  
FOR USE IN EACH SERVICE AREA  
(Including those rights acquired as successor to the  
Riverside Water Company and Gage Canal Company)

- 1 Safe Yield Adjusted Right became effective on January 1, 1972; Base Right for Calendar Year 1971 is as shown in Table B-1 of the Judgment.*
- 2 New Conservation Allocation takes effect in the first year shown and continues until further adjusted by Watermaster.  
Pursuant to Paragraph VI(b) of the Judgment, Watermaster has determined the City of Riverside New Conservation Allocation to be 1,719 acre-feet per year starting in 2013.  
The 2013 Paragraph VI(b)6 Agreement provides that Watermaster will periodically consider changing this number based on provisions of the Agreement.*
- 3 Adjusted Right equals Safe Yield Adjusted Right plus New Conservation Allocation.*
- 4 New Conservation Allocation may also be used in the San Bernardino Basin Area, or the Colton Basin Area and Riverside Basin Area in San Bernardino County.*

**VERIFIED EXTRACTIONS BY  
CITY OF RIVERSIDE  
FROM THE SAN BERNARDINO BASIN AREA  
FOR DELIVERY TO EACH SERVICE AREA  
(Including those rights acquired as successor to the  
Riverside Water Company and Gage Canal Company)  
(All Values in Acre-Feet)**

Calendar Year	San Bernardino Basin Area Extractions			Delivery for Use in San Bernardino Basin Area	Delivery for Use in San Bernardino County	Delivery for Use in Areas Outside San Bernardino Valley		
	Total Extractions	Additional Extractions	Extractions	Deliveries	Deliveries	Actual Deliveries	Additional Deliveries	Deliveries
1971	53,882		53,882	98	669	53,115		53,115
1972	45,694		45,694	85	547	45,062		45,062
1973	43,022		43,022	156	512	42,354		42,354
1974	43,367		43,367	0	550	42,817		42,817
1975	47,962		47,962	0	498	47,464		47,464
1976	51,374		51,374	0	523	50,851		50,851
1977	50,999		50,999	0	346	50,653		50,653
1978	45,384		45,384	646	301	44,437		44,437
1979	52,377		52,377	0	415	51,962		51,962
1980	50,756		50,756	383	0	50,373		50,373
1981	52,157	1,148	<i>1</i> 51,009	724	0	51,433	1,148	<i>1</i> 50,285
1982	49,599		49,599	162	0	49,437		49,437
1983	46,064	76	<i>2</i> 45,988	335	0	45,729	76	<i>2</i> 45,653
1984	58,906	9,332	<i>3</i> 49,574	32	0	58,874	9,332	<i>3</i> 49,542
1985	63,073	13,472	<i>4</i> 49,601	59	0	63,014	13,472	<i>4</i> 49,542
1986	59,979	10,000	<i>5</i> 49,979	437	0	59,542	10,000	<i>5</i> 49,542
1987	57,841	7,965	<i>6</i> 49,876	334	0	57,507	7,965	<i>6</i> 49,542
1988	64,512	14,201	<i>7</i> 50,311	815	0	63,697	14,201	<i>7</i> 49,496
1989	50,784		50,784	28	0	50,756		50,756
1990	47,637		47,637	19	0	47,618		47,618
1991	52,909	3,212	<i>8</i> 49,697	155	0	52,754	3,212	<i>8</i> 49,542
1992	50,239	7,177	<i>9</i> 43,062	203	0	50,036	7,177	<i>9</i> 42,859
1993	52,114	7,152	<i>10</i> 44,962	-108	0	52,222	9,917	<i>10</i> 42,305
1994	60,447	9,107	<i>11</i> 51,340	46	0	60,401	10,859	<i>11</i> 49,542
1995	55,392	5,799	<i>12</i> 49,593	99	0	55,293	8,357	<i>12</i> 46,936

VERIFIED EXTRACTIONS BY  
CITY OF RIVERSIDE  
FROM THE SAN BERNARDINO BASIN AREA  
FOR DELIVERY TO EACH SERVICE AREA  
(Including those rights acquired as successor to the  
Riverside Water Company and Gage Canal Company)  
(All Values in Acre-Feet)

Calendar Year	San Bernardino Basin Area Extractions			Delivery for Use in San Bernardino Basin Area	Delivery for Use in San Bernardino Basin Area and Riverside Basin Area in San Bernardino County	Delivery for Use in Areas Outside San Bernardino Valley				
	Total Extractions	Additional Extractions	Extractions	Deliveries	Deliveries	Actual Deliveries	Additional Deliveries	Deliveries		
1996	63,382	8,390	13	54,992	278	0	63,104	10,769	13	52,335
1997	59,938	7,495	14	52,443	494	0	59,444	9,658	14	49,786
1998	54,417	6,671	15	47,746	0	0	54,417	6,671	15	47,746
1999	61,142	8,943	16	52,199	181	0	60,961	11,419	16	49,542
2000	63,472	11,273	17	52,199	117	0	63,355	13,813	17	49,542
2001	59,312	7,113	18	52,199	229	0	59,083	9,541	18	49,542
2002	65,462	13,263	19	52,199	172	0	65,290	15,748	19	49,542
2003	54,514			54,514	10	0	54,504			54,504
2004	53,414	1,215	20	52,199	0	0	53,414	3,872	20	49,542
2005	44,696			44,696	13	0	44,683			44,683
2006	49,444			49,444	30	0	49,414			49,414
2007	52,018	2,459	21	49,559	39	0	51,979	2,459	21	49,520
2008	53,581			53,581	70	0	53,511			53,511
2009	43,061			43,061	121	0	42,940			42,940
2010	45,713			45,713	80	0	45,633			45,633
2011	46,488			46,488	72	0	46,416			46,416
2012	52,506			52,506	13	0	52,493			52,493
2013	50,158	(2,459)	22	52,617	11	0	50,147	(2,459)	22	52,606
2014										
2015										
2016										
2017										
2018										
2019										
2020										

VERIFIED EXTRACTIONS BY  
CITY OF RIVERSIDE  
FROM THE SAN BERNARDINO BASIN AREA  
FOR DELIVERY TO EACH SERVICE AREA  
(Including those rights acquired as successor to the  
Riverside Water Company and Gage Canal Company)

Note: See Report of Watermaster, Volume 1A, Table No. 3.

- 1 Amount deducted under December 22, 1981 Judgment Paragraph VI(b)6 Agreement (hereinafter "December 22, 1981 Agreement"). (High Groundwater Mitigation)
- 2 Amount deducted under March 3, 1983 and April 18, 1983 Letter Agreements under December 22, 1981 Agreement. (High Groundwater Mitigation)
- 3 Amount deducted under December 5, 1984 1st Amendment to December 22, 1981 Agreement. (High Groundwater Mitigation)
- 4 Amount deducted under February 25, 1985 and August 21, 1985 Agreements. (High Groundwater Mitigation)
- 5 Amount deducted under January 21, 1986 letter to City of Riverside under December 22, 1981 Agreement. (High Groundwater Mitigation)
- 6 Amount deducted under May 20, 1987 2nd Amendment to December 22, 1981 Agreement. (High Groundwater Mitigation)
- 7 Amount deducted under January 20, 1988 3rd Amendment to December 22, 1981 Agreement. (High Groundwater Mitigation)
- 8 Amount deducted under April 3, 1991 4th Amendment to December 22, 1981 Agreement. (High Groundwater Mitigation)
- 9 Amount deducted under May 4, 1992 5th Amendment to December 22, 1981 Agreement. (High Groundwater Mitigation)
- 10 Amount deducted under June 16, 1993 6th Amendment to December 22, 1981 Agreement. (High Groundwater Mitigation)
- 11 Amount deducted under March 3, 1994 7th Amendment to December 22, 1981 Agreement. (High Groundwater Mitigation)
- 12 Amount deducted under March 15, 1995 8th Amendment to December 22, 1981 Agreement. (High Groundwater Mitigation)
- 13 Amount deducted under March 6, 1996 9th Amendment to December 22, 1981 Agreement. (High Groundwater Mitigation)
- 14 Amount deducted under February 19, 1997 10th Amendment to December 22, 1981 Agreement. (High Groundwater Mitigation)
- 15 Amount deducted under February 18, 1998 11th Amendment to December 22, 1981 Agreement. (High Groundwater Mitigation)
- 16 Amount deducted under January 19, 1999 13th Amendment to December 22, 1981 Agreement. (High Groundwater Mitigation)
- 17 Amount deducted under August 16, 2000 15th Amendment to December 22, 1981 Agreement. (High Groundwater Mitigation)
- 18 Amount deducted under February 7, 2001 17th Amendment to December 22, 1981 Agreement. (High Groundwater Mitigation)
- 19 Amount deducted under February 6, 2002 19th Amendment to December 22, 1981 Agreement. (High Groundwater Mitigation)
- 20 Amount deducted under August 18, 2004 21st Amendment to December 22, 1981 Agreement. (High Groundwater Mitigation)
- 21 Amount deducted pursuant to Paragraph 5 of the August 18, 2004 Judgment Paragraph VI(b)6 agreement, see Table No. 17B-1, Footnotes 4, a, 8 and b and Table No. 17A, Footnotes 6 and c (Transfer of Imported Water)
- 22 Amount added pursuant to Paragraph 11 of the July 17, 2013 Judgment Paragraph VI(b)6 agreement, see Table No. 17B-1, Footnotes 5 and d and Table No. 17A, Footnotes 3 and e (Transfer of Imported Water)



ADJUSTED RIGHT OF  
RIVERSIDE HIGHLAND WATER COMPANY  
TO EXTRACT FROM THE SAN BERNARDINO BASIN AREA  
FOR USE IN EACH SERVICE AREA  
(All Values in Acre-Feet)

Calendar Year	San Bernardino Basin Area Adjusted Right			For Use In San Bernardino Basin Area	For Use In Colton Basin Area and Riverside Basin Area in San Bernardino County	For Use In Areas Outside San Bernardino Valley		
	Safe Yield	New	Adjusted Right 3			Adjusted Right 1	New	Adjusted Right 3
	Adjusted Right 1	Conservation Allocation 2						
1971	4,399		4,399	0	2,509	1,890		1,890
1972	4,294		4,294	0	2,449	1,845		1,845
1973	4,294		4,294	0	2,449	1,845		1,845
1974	4,294		4,294	0	2,449	1,845		1,845
1975	4,294		4,294	0	2,449	1,845		1,845
1976	4,294		4,294	0	2,449	1,845		1,845
1977	4,294		4,294	0	2,449	1,845		1,845
1978	4,294		4,294	0	2,449	1,845		1,845
1979	4,294		4,294	0	2,449	1,845		1,845
1980	4,294		4,294	0	2,449	1,845		1,845
1981	4,294		4,294	0	2,449	1,845		1,845
1982	4,294		4,294	0	2,449	1,845		1,845
1983	4,294		4,294	0	2,449	1,845		1,845
1984	4,294		4,294	0	2,449	1,845		1,845
1985	4,294		4,294	0	2,449	1,845		1,845
1986	4,294		4,294	0	2,449	1,845		1,845
1987	4,294		4,294	0	2,449	1,845		1,845
1988	4,294		4,294	0	2,449	1,845		1,845
1989	4,294		4,294	0	2,449	1,845		1,845
1990	4,294		4,294	0	2,449	1,845		1,845
1991	4,294		4,294	0	2,449	1,845		1,845
1992	4,294		4,294	0	2,449	1,845		1,845
1993	4,294		4,294	0	2,449	1,845		1,845
1994	4,294		4,294	0	2,449	1,845		1,845
1995	4,294		4,294	0	2,449	1,845		1,845

ADJUSTED RIGHT OF  
RIVERSIDE HIGHLAND WATER COMPANY  
TO EXTRACT FROM THE SAN BERNARDINO BASIN AREA  
FOR USE IN EACH SERVICE AREA  
(All Values in Acre-Feet)

Calendar Year	San Bernardino Basin Area Adjusted Right			For Use In San Bernardino Basin Area	For Use In Colton Basin Area and Riverside Basin Area in San Bernardino County	For Use In Areas Outside San Bernardino Valley		
	Safe Yield	New	Adjusted Right 3	Adjusted Right 4	Adjusted Right 4	Safe Yield	New	Adjusted Right 3
	Adjusted Right 1	Conservation Allocation 2				Adjusted Right 1	Conservation Allocation 2	
1996	4,294		4,294	0	2,449	1,845		1,845
1997	4,294		4,294	0	2,449	1,845		1,845
1998	4,294		4,294	0	2,449	1,845		1,845
1999	4,294		4,294	0	2,449	1,845		1,845
2000	4,294		4,294	0	2,449	1,845		1,845
2001	4,294		4,294	0	2,449	1,845		1,845
2002	4,294		4,294	0	2,449	1,845		1,845
2003	4,294		4,294	0	2,449	1,845		1,845
2004	4,294		4,294	0	2,449	1,845		1,845
2005	4,294		4,294	0	2,449	1,845		1,845
2006	4,294		4,294	0	2,449	1,845		1,845
2007	4,294		4,294	0	2,449	1,845		1,845
2008	4,294		4,294	0	2,449	1,845		1,845
2009	4,294		4,294	0	2,449	1,845		1,845
2010	4,294		4,294	0	2,449	1,845		1,845
2011	4,294		4,294	0	2,449	1,845		1,845
2012	4,294		4,294	0	2,449	1,845		1,845
2013	4,294	141	4,435	0	2,449	1,845	141	1,986
2014	4,294	141	4,435	0	2,449	1,845	141	1,986
2015	4,294	141	4,435	0	2,449	1,845	141	1,986
2016	4,294	141	4,435	0	2,449	1,845	141	1,986
2017	4,294	141	4,435	0	2,449	1,845	141	1,986
2018	4,294	141	4,435	0	2,449	1,845	141	1,986
2019	4,294	141	4,435	0	2,449	1,845	141	1,986
2020	4,294	141	4,435	0	2,449	1,845	141	1,986

ADJUSTED RIGHT OF  
RIVERSIDE HIGHLAND WATER COMPANY  
TO EXTRACT FROM THE SAN BERNARDINO BASIN AREA  
FOR USE IN EACH SERVICE AREA

*1 Safe Yield Adjusted Right became effective on January 1, 1972; Base Right for Calendar Year 1971 is as shown in Table B-1 of the Judgment.*

*2 New Conservation Allocation takes effect in the first year shown and continues until further adjusted by Watermaster.*

*Pursuant to Paragraph VI(b) of the Judgment, Watermaster has determined the Riverside Highland Water Company New Conservation Allocation to be 141 acre-feet per year starting in 2013.*

*The 2013 Paragraph VI(b)6 Agreement provides that Watermaster will periodically consider changing this number based on provisions of the Agreement.*

*3 Adjusted Right equals Safe Yield Adjusted Right plus New Conservation Allocation*

*4 New Conservation Allocation may also be used in the San Bernardino Basin Area, or the Colton Basin Area and Riverside Basin Area in San Bernardino County.*

VERIFIED EXTRACTIONS BY  
RIVERSIDE HIGHLAND WATER COMPANY  
FROM THE SAN BERNARDINO BASIN AREA  
FOR DELIVERY TO EACH SERVICE AREA

(All Values in Acre-Feet)

Calendar Year	San Bernardino Basin Area Extractions			Delivery for Use in San Bernardino Basin Area	Delivery for Use in San Bernardino County	Delivery for Use in Areas Outside San Bernardino Valley		
	Total Extractions	Additional Extractions	Extractions	Deliveries	Deliveries	Actual Deliveries	Additional Deliveries	Deliveries
1971	4,012		4,012	0	2,388	1,624		1,624
1972	4,532		4,532	0	2,239	2,293		2,293
1973	3,512		3,512	0	1,751	1,761		1,761
1974	4,088		4,088	0	1,985	2,103		2,103
1975	4,709		4,709	0	2,002	2,707		2,707
1976	4,519		4,519	0	2,050	2,469		2,469
1977	3,583		3,583	0	1,820	1,763		1,763
1978	1,350		1,350	0	1,051	299		299
1979	3,369		3,369	0	1,781	1,588		1,588
1980	3,677		3,677	0	2,060	1,617		1,617
1981	3,604		3,604	0	2,151	1,453		1,453
1982	2,795		2,795	0	1,775	1,020		1,020
1983	3,161		3,161	0	2,318	843		843
1984	4,759		4,759	0	2,671	2,088		2,088
1985	3,312		3,312	0	1,978	1,334		1,334
1986	4,744		4,744	0	2,130	2,614		2,614
1987	3,919		3,919	0	2,229	1,690		1,690
1988	4,775		4,775	0	2,229	2,546		2,546
1989	4,681		4,681	0	1,968	2,713		2,713
1990	4,092		4,092	0	2,313	1,779		1,779
1991	3,021		3,021	0	1,669	1,352		1,352
1992	4,052		4,052	0	2,275	1,777		1,777
1993	3,241		3,241	0	1,777	1,464		1,464
1994	4,324		4,324	0	2,201	2,123		2,123
1995	3,955		3,955	0	2,146	1,809		1,809

VERIFIED EXTRACTIONS BY  
RIVERSIDE HIGHLAND WATER COMPANY  
FROM THE SAN BERNARDINO BASIN AREA  
FOR DELIVERY TO EACH SERVICE AREA

(All Values in Acre-Feet)

Calendar Year	San Bernardino Basin Area Extractions			Delivery for Use in San Bernardino Basin Area	Delivery for Use in San Bernardino County	Delivery for Use in Areas Outside San Bernardino Valley				
	Total Extractions	Additional Extractions	Extractions	Deliveries	Deliveries	Actual Deliveries	Additional Deliveries	Deliveries	Deliveries	
1996	5,051	463	1	4,588	0	2,756	2,295	463	1	1,832
1997	4,939	463	2	4,476	0	2,656	2,283	463	2	1,820
1998	3,250	463	3	2,787	0	1,961	1,289	463	3	826
1999	4,972	2,041	4	2,931	0	2,082	2,890	2,041	4	849
2000	3,423	567	5	2,856	0	2,811	612	567	5	45
2001	2,925	260	6	2,665	0	2,543	382	260	6	122
2002	4,310	1,910	7	2,400	0	2,272	2,038	1,910	7	128
2003	3,881	3	7	3,878	0	2,036	1,845	3	7	1,842
2004	1,754	0		1,754	0	1,301	453	0		453
2005	3,377			3,377	0	1,532	1,845			1,845
2006	4,149			4,149	0	2,304	1,845			1,845
2007	3,633			3,633	0	1,772	1,861			1,861
2008	2,730			2,730	0	2,054	676			676
2009	1,648			1,648	0	1,073	575			575
2010	1,136			1,136	0	629	507			507
2011	1,655			1,655	0	1,087	568			568
2012	2,135			2,135	0	1,523	612			612
2013	2,873			2,873	0	1,629	1,244			1,244
2014										
2015										
2016										
2017										
2018										
2019										
2020										

VERIFIED EXTRACTIONS BY  
RIVERSIDE HIGHLAND WATER COMPANY  
FROM THE SAN BERNARDINO BASIN AREA  
FOR DELIVERY TO EACH SERVICE AREA

Note: See Report of Watermaster, Volume 1A, Table No. 3.

*1 Amount deducted under March 6, 1996 9th Amendment to December 22, 1981 Judgment Paragraph VI(b)6 Agreement (hereinafter "December 22, 1981 Agreement"). (High Groundwater Mitigation)*

*2 Amount deducted under February 19, 1997 10th Amendment to December 22, 1981 Agreement. (High Groundwater Mitigation)*

*3 Amount deducted under February 18, 1998 11th Amendment to December 22, 1981 Agreement. (High Groundwater Mitigation)*

*4 Amount deducted under January 19, 1999 13th Amendment to December 22, 1981 Agreement. (High Groundwater Mitigation)*

*5 Amount deducted under August 16, 2000 15th Amendment to December 22, 1981 Agreement. (High Groundwater Mitigation)*

*6 Amount deducted under February 7, 2001 17th Amendment to December 22, 1981 Agreement. (High Groundwater Mitigation)*

*7 Amount deducted under February 6, 2002 19th Amendment to December 22, 1981 Agreement. (High Groundwater Mitigation)*

ADJUSTED RIGHT OF  
 AGUA MANSA WATER COMPANY AND MEEKS & DALEY WATER COMPANY  
 TO EXTRACT FROM THE SAN BERNARDINO BASIN AREA  
 FOR USE IN EACH SERVICE AREA  
 (All Values in Acre-Feet)

Calendar Year	San Bernardino Basin Area Adjusted Right			For Use In San Bernardino Basin Area	For Use In Colton Basin Area and Riverside Basin Area in San Bernardino County	For Use In Areas Outside San Bernardino Valley		
	Safe Yield	New	Adjusted Right 3	Adjusted Right 4	Adjusted Right 4	Safe Yield	New	Adjusted Right 3
	Adjusted Right 1	Conservation Allocation 2				Adjusted Right 1	Conservation Allocation 2	
1971	8,026		8,026	0	325	7,700		7,700
1972	7,833		7,833	0	318	7,515		7,515
1973	7,833		7,833	0	318	7,515		7,515
1974	7,833		7,833	0	318	7,515		7,515
1975	7,833		7,833	0	318	7,515		7,515
1976	7,833		7,833	0	318	7,515		7,515
1977	7,833		7,833	0	318	7,515		7,515
1978	7,833		7,833	0	318	7,515		7,515
1979	7,833		7,833	0	318	7,515		7,515
1980	7,833		7,833	0	318	7,515		7,515
1981	7,833		7,833	0	318	7,515		7,515
1982	7,833		7,833	0	318	7,515		7,515
1983	7,833		7,833	0	318	7,515		7,515
1984	7,833		7,833	0	318	7,515		7,515
1985	7,833		7,833	0	318	7,515		7,515
1986	7,833		7,833	0	318	7,515		7,515
1987	7,833		7,833	0	318	7,515		7,515
1988	7,833		7,833	0	318	7,515		7,515
1989	7,833		7,833	0	318	7,515		7,515
1990	7,833		7,833	0	318	7,515		7,515
1991	7,833		7,833	0	318	7,515		7,515
1992	7,833		7,833	0	318	7,515		7,515
1993	7,833		7,833	0	318	7,515		7,515
1994	7,833		7,833	0	318	7,515		7,515
1995	7,833		7,833	0	318	7,515		7,515

ADJUSTED RIGHT OF  
 AGUA MANSÁ WATER COMPANY AND MEEKS & DALEY WATER COMPANY  
 TO EXTRACT FROM THE SAN BERNARDINO BASIN AREA  
 FOR USE IN EACH SERVICE AREA  
 (All Values in Acre-Feet)

Calendar Year	San Bernardino Basin Area Adjusted Right			For Use In San Bernardino Basin Area	For Use In Colton Basin Area and Riverside Basin Area in San Bernardino County	For Use In Areas Outside San Bernardino Valley		
	Safe Yield	New	Adjusted Right 3	Adjusted Right 4	Adjusted Right 4	Safe Yield	New	Adjusted Right 3
	Adjusted Right 1	Conservation Allocation 2				Adjusted Right 1	Conservation Allocation 2	
1996	7,833		7,833	0	318	7,515		7,515
1997	7,833		7,833	0	318	7,515		7,515
1998	7,833		7,833	0	318	7,515		7,515
1999	7,833		7,833	0	318	7,515		7,515
2000	7,833		7,833	0	318	7,515		7,515
2001	7,833		7,833	0	318	7,515		7,515
2002	7,833		7,833	0	318	7,515		7,515
2003	7,833		7,833	0	318	7,515		7,515
2004	7,833		7,833	0	318	7,515		7,515
2005	7,833		7,833	0	318	7,515		7,515
2006	7,833		7,833	0	318	7,515		7,515
2007	7,833		7,833	0	318	7,515		7,515
2008	7,833		7,833	0	318	7,515		7,515
2009	7,833		7,833	0	318	7,515		7,515
2010	7,833		7,833	0	318	7,515		7,515
2011	7,833		7,833	0	318	7,515		7,515
2012	7,833		7,833	0	318	7,515		7,515
2013	7,833	258	8,091	0	318	7,515	258	7,773
2014	7,833	258	8,091	0	318	7,515	258	7,773
2015	7,833	258	8,091	0	318	7,515	258	7,773
2016	7,833	258	8,091	0	318	7,515	258	7,773
2017	7,833	258	8,091	0	318	7,515	258	7,773
2018	7,833	258	8,091	0	318	7,515	258	7,773
2019	7,833	258	8,091	0	318	7,515	258	7,773
2020	7,833	258	8,091	0	318	7,515	258	7,773



ADJUSTED RIGHT OF  
AGUA MANSA WATER COMPANY AND MEEKS & DALEY WATER COMPANY  
TO EXTRACT FROM THE SAN BERNARDINO BASIN AREA  
FOR USE IN EACH SERVICE AREA

*1 Safe Yield Adjusted Right became effective on January 1, 1972; Base Right for Calendar Year 1971 is as shown in Table B-1 of the Judgment.*

*2 New Conservation Allocation takes effect in the first year shown and continues until further adjusted by Watermaster.*

*Pursuant to Paragraph VI(b) of the Judgment, Watermaster has determined the Agua Mansa Water Company and Meeks & Daley Water Company New Conservation Allocation to be 258 acre-feet per year starting in 2013.*

*The 2013 Paragraph VI(b)6 Agreement provides that Watermaster will periodically consider changing this number based on provisions of the Agreement.*

*3 Adjusted Right equals Safe Yield Adjusted Right plus New Conservation Allocation*

*4 New Conservation Allocation may also be used in the San Bernardino Basin Area, or the Colton Basin Area and Riverside Basin Area in San Bernardino County.*

VERIFIED EXTRACTIONS BY  
 AGUA MANSA WATER COMPANY AND MEEKS & DALEY WATER COMPANY  
 FROM THE SAN BERNARDINO BASIN AREA  
 FOR DELIVERY TO EACH SERVICE AREA  
 (All Values in Acre-Feet)

Calendar Year	San Bernardino Basin Area Extractions			Delivery for Use in San Bernardino Basin Area	Delivery for Use in Colton Basin Area and Riverside Basin Area in San Bernardino County	Delivery for Use in Areas Outside San Bernardino Valley		
	Total Extractions	Additional Extractions	Extractions	Deliveries	Deliveries	Actual Deliveries	Additional Deliveries	Deliveries
1971	2,902		2,902	0	383	2,519		2,519
1972	3,527		3,527	0	377	3,150		3,150
1973	2,979		2,979	0	250	2,729		2,729
1974	4,504		4,504	0	246	4,258		4,258
1975	3,950		3,950	0	168	3,782		3,782
1976	5,393		5,393	0	182	5,211		5,211
1977	4,220		4,220	0	146	4,074		4,074
1978	2,254		2,254	0	161	2,093		2,093
1979	3,930		3,930	0	166	3,764		3,764
1980	2,333		2,333	0	323	2,010		2,010
1981	3,092		3,092	0	358	2,734		2,734
1982	3,716		3,716	0	169	3,547		3,547
1983	2,651		2,651	0	245	2,406		2,406
1984	5,165		5,165	0	233	4,932		4,932
1985	5,385		5,385	0	210	5,175		5,175
1986	5,570		5,570	0	234	5,336		5,336
1987	4,914		4,914	0	193	4,721		4,721
1988	4,966		4,966	0	233	4,733		4,733
1989	5,392		5,392	0	240	5,152		5,152
1990	3,851		3,851	0	83	3,768		3,768
1991	4,426		4,426	0	190	4,236		4,236
1992	4,100		4,100	0	118	3,982		3,982
1993	5,013		5,013	0	276	4,737		4,737
1994	4,525		4,525	0	227	4,298		4,298
1995	3,560		3,560	0	145	3,415		3,415

VERIFIED EXTRACTIONS BY  
 AGUA MANSA WATER COMPANY AND MEEKS & DALEY WATER COMPANY  
 FROM THE SAN BERNARDINO BASIN AREA  
 FOR DELIVERY TO EACH SERVICE AREA  
 (All Values in Acre-Feet)

Calendar Year	San Bernardino Basin Area Extractions			Delivery for Use in San Bernardino Basin Area	Delivery for Use in Colton Basin Area and Riverside Basin Area in San Bernardino County	Delivery for Use in Areas Outside San Bernardino Valley		
	Total Extractions	Additional Extractions	Extractions	Deliveries	Deliveries	Actual Deliveries	Additional Deliveries	Deliveries
1996	3,912		3,912	0	194	3,718		3,718
1997	4,165		4,165	0	137	4,028		4,028
1998	3,828		3,828	0	210	3,618		3,618
1999	6,289		6,289	0	90	6,199		6,199
2000	3,832		3,832	0	352	3,480		3,480
2001	3,671		3,671	0	192	3,479		3,479
2002	5,800		5,800	0	202	5,598		5,598
2003	7,440		7,440	0	49	7,391		7,391
2004	3,782		3,782	0	19	3,763		3,763
2005	5,891		5,891	0	4	5,887		5,887
2006	7,515		7,515	0	0	7,515		7,515
2007	7,591		7,591	0	0	7,591		7,591
2008	4,832		4,832	0	0	4,832		4,832
2009	6,345		6,345	0	0	6,345		6,345
2010	6,738		6,738	0	0	6,738		6,738
2011	7,127		7,127	0	0	7,127		7,127
2012	7,117		7,117	0	0	7,117		7,117
2013	7,732		7,732	0	0	7,732		7,732
2014								
2015								
2016								
2017								
2018								
2019								
2020								

VERIFIED EXTRACTIONS BY  
AGUA MANSA WATER COMPANY AND MEEKS & DALEY WATER COMPANY  
FROM THE SAN BERNARDINO BASIN AREA  
FOR DELIVERY TO EACH SERVICE AREA

Note: See Report of Watermaster, Volume 1A, Table No. 3.

ADJUSTED RIGHT OF  
THE REGENTS OF THE UNIVERSITY OF CALIFORNIA  
TO EXTRACT FROM THE SAN BERNARDINO BASIN AREA  
FOR USE IN EACH SERVICE AREA  
(All Values in Acre-Feet)

Calendar Year	San Bernardino Basin Area Adjusted Right			For Use In San Bernardino Basin Area	For Use In Colton Basin Area and Riverside Basin Area in San Bernardino County	For Use In Areas Outside San Bernardino Valley		
	Safe Yield	New	Adjusted Right 3	Adjusted Right 4	Adjusted Right 4	Safe Yield	New	Adjusted Right 3
	Adjusted Right 1	Conservation Allocation 2				Adjusted Right 1	Conservation Allocation 2	
1971	581		581	0	0	581		581
1972	536		536	0	0	536		536
1973	536		536	0	0	536		536
1974	536		536	0	0	536		536
1975	536		536	0	0	536		536
1976	536		536	0	0	536		536
1977	536		536	0	0	536		536
1978	536		536	0	0	536		536
1979	536		536	0	0	536		536
1980	536		536	0	0	536		536
1981	536		536	0	0	536		536
1982	536		536	0	0	536		536
1983	536		536	0	0	536		536
1984	536		536	0	0	536		536
1985	536		536	0	0	536		536
1986	536		536	0	0	536		536
1987	536		536	0	0	536		536
1988	536		536	0	0	536		536
1989	536		536	0	0	536		536
1990	536		536	0	0	536		536
1991	536		536	0	0	536		536
1992	536		536	0	0	536		536
1993	536		536	0	0	536		536
1994	536		536	0	0	536		536
1995	536		536	0	0	536		536

ADJUSTED RIGHT OF  
THE REGENTS OF THE UNIVERSITY OF CALIFORNIA  
TO EXTRACT FROM THE SAN BERNARDINO BASIN AREA  
FOR USE IN EACH SERVICE AREA  
(All Values in Acre-Feet)

Calendar Year	San Bernardino Basin Area Adjusted Right			For Use In San Bernardino Basin Area	For Use In Colton Basin Area and Riverside Basin Area in San Bernardino County	For Use In Areas Outside San Bernardino Valley				
	Safe Yield	New	Adjusted Right 3			Adjusted Right 4	Adjusted Right 4	Safe Yield	New	Adjusted Right 3
	Adjusted Right 1	Conservation Allocation 2						Adjusted Right 1	Conservation Allocation 2	
1996	536		536	0	0	536		536		
1997	536		536	0	0	536		536		
1998	536		536	0	0	536		536		
1999	536		536	0	0	536		536		
2000	536		536	0	0	536		536		
2001	536		536	0	0	536		536		
2002	536		536	0	0	536		536		
2003	536		536	0	0	536		536		
2004	536		536	0	0	536		536		
2005	536		536	0	0	536		536		
2006	536		536	0	0	536		536		
2007	536		536	0	0	536		536		
2008	536		536	0	0	536		536		
2009	536		536	0	0	536		536		
2010	536		536	0	0	536		536		
2011	536		536	0	0	536		536		
2012	536		536	0	0	536		536		
2013	536	18	554	0	0	536	18	554		
2014	536	18	554	0	0	536	18	554		
2015	536	18	554	0	0	536	18	554		
2016	536	18	554	0	0	536	18	554		
2017	536	18	554	0	0	536	18	554		
2018	536	18	554	0	0	536	18	554		
2019	536	18	554	0	0	536	18	554		
2020	536	18	554	0	0	536	18	554		

ADJUSTED RIGHT OF  
THE REGENTS OF THE UNIVERSITY OF CALIFORNIA  
TO EXTRACT FROM THE SAN BERNARDINO BASIN AREA  
FOR USE IN EACH SERVICE AREA

*1 Safe Yield Adjusted Right became effective on January 1, 1972; Base Right for Calendar Year 1971 is as shown in Table B-1 of the Judgment.*

*2 New Conservation Allocation takes effect in the first year shown and continues until further adjusted by Watermaster. Pursuant to Paragraph VI(b) of the Judgment, Watermaster has determined The Regents of the University of California New Conservation Allocation to be 18 acre-feet per year starting in 2013. The 2013 Paragraph VI(b)6 Agreement provides that Watermaster will periodically consider changing this number based on provisions of the Agreement.*

*3 Adjusted Right equals Safe Yield Adjusted Right plus New Conservation Allocation*

*4 New Conservation Allocation may also be used in the San Bernardino Basin Area, or the Colton Basin Area and Riverside Basin Area in San Bernardino County.*

VERIFIED EXTRACTIONS BY  
THE REGENTS OF THE UNIVERSITY OF CALIFORNIA  
FROM THE SAN BERNARDINO BASIN AREA  
FOR DELIVERY TO EACH SERVICE AREA  
(All Values in Acre-Feet)

Calendar Year	San Bernardino Basin Area Extractions			Delivery for Use in San Bernardino Basin Area	Delivery for Use in Colton Basin Area and Riverside Basin Area in San Bernardino County	Delivery for Use in Areas Outside San Bernardino Valley		
	Total Extractions	Additional Extractions	Extractions	Deliveries	Deliveries	Actual Deliveries	Additional Deliveries	Deliveries
1971	219		219	0	0	219		219
1972	239		239	0	0	239		239
1973	239		239	0	0	239		239
1974	267		267	0	0	267		267
1975	179		179	0	0	179		179
1976	245		245	0	0	245		245
1977	87		87	0	0	87		87
1978	183		183	0	0	183		183
1979	83		83	0	0	83		83
1980	7		7	0	0	7		7
1981	143		143	0	0	143		143
1982	48		48	0	0	48		48
1983	0		0	0	0	0		0
1984	0		0	0	0	0		0
1985	0		0	0	0	0		0
1986	48		48	0	0	48		48
1987	195		195	0	0	195		195
1988	179		179	0	0	179		179
1989	62		62	0	0	62		62
1990	95		95	0	0	95		95
1991	23		23	0	0	23		23
1992	32		32	0	0	32		32
1993	0		0	0	0	0		0
1994	0		0	0	0	0		0
1995	0		0	0	0	0		0



VERIFIED EXTRACTIONS BY  
THE REGENTS OF THE UNIVERSITY OF CALIFORNIA  
FROM THE SAN BERNARDINO BASIN AREA  
FOR DELIVERY TO EACH SERVICE AREA  
(All Values in Acre-Feet)

Calendar Year	San Bernardino Basin Area Extractions			Delivery for Use in San Bernardino Basin Area	Delivery for Use in Colton Basin Area and Riverside Basin Area in San Bernardino County	Delivery for Use in Areas Outside San Bernardino Valley		
	Total Extractions	Additional Extractions	Extractions	Deliveries	Deliveries	Actual Deliveries	Additional Deliveries	Deliveries
1996	445		445	0	0	445		445
1997	505	58 1	447	0	0	505	58 1	447
1998	590	54 2	536	0	0	590	54 2	536
1999	586	50 3	536	0	0	586	50 3	536
2000	624	88 4	536	0	0	624	88 4	536
2001	617	81 5	536	0	0	617	81 5	536
2002	618	82 6	536	0	0	618	82 6	536
2003	536		536	0	0	536		536
2004	618	82 7	536	0	0	618	82 7	536
2005	536		536	0	0	536		536
2006	536		536	0	0	536		536
2007	536		536	0	0	536		536
2008	536		536	0	0	536		536
2009	536		536	0	0	536		536
2010	536		536	0	0	536		536
2011	536		536	0	0	536		536
2012	536		536	0	0	536		536
2013	536		536	0	0	536		536
2014								
2015								
2016								
2017								
2018								
2019								
2020								

VERIFIED EXTRACTIONS BY  
THE REGENTS OF THE UNIVERSITY OF CALIFORNIA  
FROM THE SAN BERNARDINO BASIN AREA  
FOR DELIVERY TO EACH SERVICE AREA

Note: See Report of Watermaster, Volume 1A, Table No. 3.

*1 Extracted or exported under February 19, 1997 10th Amendment to December 22, 1981 agreements. (High Groundwater Mitigation)*

*2 Extracted or exported under February 18, 1998 11th Amendment to December 22, 1981 agreements. (High Groundwater Mitigation)*

*3 Extracted or exported under January 19, 1999 13th Amendment to December 22, 1981 agreements. (High Groundwater Mitigation)*

*4 Extracted or exported under August 16, 2000 15th Amendment to December 22, 1981 agreements. (High Groundwater Mitigation)*

*5 Extracted or exported under February 7, 2001 17th Amendment to December 22, 1981 agreements. (High Groundwater Mitigation)*

*6 Extracted or exported under February 6, 2002 19th Amendment to December 22, 1981 agreements. (High Groundwater Mitigation)*

*7 Extracted or exported under August 18, 2004 21st Amendment to December 22, 1981 agreements. (High Groundwater Mitigation)*

**CHAPTER IV**

**NATURAL SAFE YIELD OF THE  
SAN BERNARDINO BASIN AREA AND  
ADJUSTED RIGHTS OF PLAINTIFF EXPORTERS**

## CHAPTER IV

### NATURAL SAFE YIELD OF THE SAN BERNARDINO BASIN AREA AND ADJUSTED RIGHTS OF PLAINTIFF EXPORTERS

The Watermaster has determined the natural safe yield of the water supply accruing to the San Bernardino Basin Area at 232,100 acre-feet per annum from which the Adjusted Rights of Plaintiff exporters were also determined. Such determination of safe yield and Adjusted Rights of Plaintiff exporters was set forth in detail in 1972 in Report of Watermaster, Volume 9, titled *Determination of Natural Safe Yield of the San Bernardino Basin Area and Adjusted Rights of Plaintiff Exporters*.

The Adjusted Rights of Plaintiff extractions from the San Bernardino Basin Area, classified according to service areas and based on the natural safe yield of 232,100 acre-feet per annum have been summarized on the following table.

PLAINTIFF ADJUSTED RIGHTS  
CLASSIFIED ACCORDING TO SERVICE AREA <sup>1</sup>  
(All Values in Acre-Feet)

Plaintiffs	Total Extractions in San Bernardino Basin Area	Delivery to San Bernardino Basin Area	Delivery to Colton Basin and Riverside Basin Area in San Bernardino County	Delivery to Areas Outside San Bernardino Valley
City of Riverside	52,199 <sup>2</sup>	1,427	1,230	49,542 <sup>2</sup>
Riverside Highland Water Company	4,294	0	2,449	1,845
Agua Mansa Water Company and Meeks & Daley Water Company	7,833	0	318	7,515
Regents of The University of California	536 <sup>2</sup>	0	0	536 <sup>2</sup>
<b>TOTAL</b>	<b>64,862</b>	<b>1,427</b>	<b>3,997</b>	<b>59,438</b>

<sup>1</sup> Effective January 1, 1972. Therefore, the 1971 rights for both Plaintiffs and other than Plaintiffs are equal to the five-year base period average.

<sup>2</sup> The Adjusted Rights allocated to the City of Riverside and The Regents of The University of California were established at 52,169 and 566 acre-feet per annum respectively. On the basis of an amended recordation filing for the 1959-63 Base Period, the adjusted right for The Regents of The University of California was reduced to 536 acre-feet, and the City of Riverside adjusted right was increased to 52,199 acre-feet.

Paragraph VI(b)1(b) of the Judgment provides that the safe yield Adjusted Rights of Plaintiffs shown in the table above can be further adjusted to reflect new conservation. New conservation is defined in Judgment Paragraph IV(i) as, “Any increase in replenishment from natural precipitation which results from operation of works and facilities not in existence when safe yield was determined ...”. The construction of Seven Oaks Dam has resulted in new conservation.

Commencing in 2013, Adjusted Rights of Plaintiffs have been increased based on calculations of the long term average increase in yield resulting from operation of Seven Oaks Reservoir. The amounts of such increase are shown as the New Conservation Allocation on Table Nos. 3A-1 through 3D-1. Therefore, commencing in 2013 the Adjusted Rights for Plaintiffs shown on Table Nos. 3A-1 through 3D-1 are the sum of the Safe Yield Adjusted Right (shown in the table above) and the New Conservation Allocation.

The Adjusted Right of other than Plaintiffs was also based on the natural safe yield of the San Bernardino Basin Area and was determined in 1972 to be 167,238 acre-feet. The Safe Yield Adjusted Right of users other than Plaintiffs of 167,238 acre-feet has also been further adjusted pursuant to Judgment Paragraph VI(c) to reflect the New Conservation Allocation. Therefore, commencing in 2013 the Adjusted Right of users other than Plaintiffs is shown on Table No. 2, page 1, as the sum of the Safe Yield Adjusted Right and the New Conservation Allocation.

The Judgment provides for continuing jurisdiction of the Court in the following matters:

- 1) The hydrologic condition of any one or all of the separate basins described in this Judgment in order to determine from time to time the safe yield of the San Bernardino Basin Area, and

- 2) The adjusted rights of the Plaintiffs as required to comply with the provisions hereof with respect to changes in the natural safe yield of the San Bernardino Basin Area. If such changes occur, the Court shall adjudge that the Adjusted Rights and replenishment obligations of each Party shall be changed proportionately to the base rights.

In order to provide a basis for future re-determinations of safe yield, the Watermaster maintains a continuing program of collecting and analyzing current hydrologic data pertinent to the annual water supply to, and utilization of water from, the San Bernardino Basin Area.

Such data will be summarized and reported from time to time in subsequent supplemental reports of the Watermaster.

**CHAPTER V**

**EXTRACTIONS FROM COLTON BASIN AREA AND  
RIVERSIDE BASIN AREA WITHIN SAN BERNARDINO  
COUNTY**

## CHAPTER V

### EXTRACTIONS FROM THE COLTON BASIN AREA AND RIVERSIDE BASIN AREA WITHIN SAN BERNARDINO COUNTY

#### For Use Outside San Bernardino Valley

The extractions from the Colton Basin Area and that portion of the Riverside Basin Area within San Bernardino County for use in Riverside County during the 2013 calendar year have been verified by the Watermaster as 81 acre-feet and 12,600 acre-feet, respectively. The individual work sheets for these determinations are included in Report of Watermaster, Volume 2-2013 titled *Verified Extractions From the Colton Basin Area* in Table No. 4, Volume 3-2013 titled *Verified Extractions From Riverside Basin Area Within San Bernardino County* in Table No. 4, and Volume 5-2013 titled *Distribution of Extractions From the San Bernardino Basin Area, Colton Basin Area, and Riverside Basin Area for Use Outside the San Bernardino Valley Municipal Water District* in Table No. 57.

#### For Use Within San Bernardino Valley

Provided minimum groundwater surface elevations within the Colton Basin Area and that portion of Riverside Basin Area within San Bernardino County are maintained by San Bernardino Valley, extractions from the Colton Basin Area and that portion of the Riverside Basin Area within San Bernardino County for use within San Bernardino Valley are not limited and therefore verification of such amounts are not specifically required by the Judgment. However, proper allocation of the total extractions from these areas for use in areas outside San Bernardino Valley necessitates the verification of these extractions. The



individual work sheets for the 2013 verification and distribution of extractions are also included in Report of Watermaster, Volumes 2-2013, 3-2013 and 5-2013.

The extractions from the Colton Basin Area and the Riverside Basin Area in San Bernardino County for calendar years 1971 through 2013 are summarized in Table Nos. 4 and 5 following.

TABLE NO. 4  
 VERIFIED EXTRACTIONS FROM COLTON BASIN AREA  
 BY SAN BERNARDINO AND RIVERSIDE COUNTY ENTITIES  
 FOR USE IN EACH COUNTY  
 ANNUAL TOTALS  
 (All Values in Acre-Feet)

Calendar Year	Total from Basin	Extracted by San Bernardino County Entities		Total	Used in San Bernardino County		Used in Riverside County		Base Right for Use in Riverside County		
Five-Year Base Period											
1959-63 Avg.	11,731	2	8,235	2	3,496	115	3,381	3,381	1		
1971	11,388	2	8,363	2	3,025	248	2,777	3,381			
1972	10,414		7,532		2,882	271	2,611	3,381			
1973	7,844		6,982		862	247	615	3,381			
1974	8,906		7,169		1,737	273	1,464	3,381			
1975	11,083		6,821		4,262	389	3,873	3,381			
1976	11,558	2	8,605	2	2,953	265	2,688	2	3,381		
1977	8,777		6,061		2,716	447	2,269		3,381		
1978	7,663		6,430		1,233	338	895		3,381		
1979	7,194		5,224		1,970	288	1,682		3,381		
1980	5,686	2	5,610	2	76	2	0	76	2	3,381	
1981	6,348		6,175		173		0	173		3,381	
1982	6,499		5,450		1,049		68	981		3,381	
1983	4,735	2	4,603	2	132		37	95		3,381	
1984	8,987		7,441		1,546	205	2	1,341	2	3,381	
1985	10,149		7,142		3,007	764	2	2,243	2	3,381	
1986	10,035		7,651		2,384	806	2	1,578	2	3,381	
1987	13,175		11,054		2,121	565	2	1,556	2	3,381	
1988	13,552		11,453		2,099	392		1,707		3,381	
1989	14,103	2	11,799	2	2,304	299		2,005		3,381	
1990	17,571	2	15,551	2	2,020	368		1,652		3,381	
1991	14,323		12,282		2,041	206		1,835		3,381	
1992	16,750		15,068		1,682	227		1,455		3,381	
1993	14,977		14,581		396	0		396		3,381	
1994	15,813	2	14,652	2	1,161	95		1,066		3,381	
1995	17,308	2	16,693	2	615	126		489		3,381	
1996	17,040	2	16,385	2	655	78		577		3,381	
1997	14,498	2	13,276	2	1,222	81		1,141		3,381	
1998	10,972	2	10,689	2	283	32		251		3,381	
1999	12,564	2	11,430	2	1,134	222		912		3,381	
2000	13,123	2	12,837	2	286	2	73	2	213	2	3,381

TABLE NO. 4  
 VERIFIED EXTRACTIONS FROM COLTON BASIN AREA  
 BY SAN BERNARDINO AND RIVERSIDE COUNTY ENTITIES  
 FOR USE IN EACH COUNTY  
 ANNUAL TOTALS  
 (All Values in Acre-Feet)

Calendar Year	Total from Basin	Extracted by San Bernardino County Entities		Total	Used in San Bernardino County		Used in Riverside County		Base Right for Use in Riverside County	1
		Total	2		Total	2	Total	2		
Five-Year Base Period										
1959-63 Avg.	11,731	2	8,235	2	3,496	115	2	3,381	2	3,381
2001	16,389	2	16,056	2	333	168	2	165	2	3,381
2002	19,161	2	17,766	2	1,395	116	2	1,279	2	3,381
2003	25,656	2	24,576	2	1,080	18	2	1,062	2	3,381
2004	24,346	2	24,167	2	179	7	2	172	2	3,381
2005	18,814	2	18,727	2	87	3	2	84	2	3,381
2006	17,566	2	17,154	2	412	0		412		3,381
2007	20,988	2	20,246	2	742	0		742		3,381
2008	20,658	2	19,719	2	939	0		939		3,381
2009	23,536		23,158		378	0		378		3,381
2010	24,455		24,378		77	0		77		3,381
2011	20,573		20,400		173	0		173		3,381
2012	20,149		20,075		74	0		74		3,381
2013	21,000		20,919		81	0		81		3,381
2014										
2015										
2016										
2017										
2018										
2019										
2020										

Note: See Report of Watermaster, Volume 2, Tables 4 & 5; and Volume 5, Table 38.

1 Extractions for use in Riverside County are limited to the verified extractions for the five-year Base Period 1959-63

2 Amount corrected during a subsequent year verification of extractions.

VERIFIED EXTRACTIONS FROM COLTON BASIN AREA  
 BY SAN BERNARDINO AND RIVERSIDE COUNTY ENTITIES  
 FOR USE IN EACH COUNTY  
 FIVE-YEAR TOTALS  
 (All Values in Acre-Feet)

Five-Year Period	Total from Basin	Extracted by San Bernardino County Entities	Extracted by Riverside County Entities			
			Total	Used in San Bernardino County	Used in Riverside County	Base Right for Use in Riverside County <sup>1</sup>
Five-Year Base Period 1959-63	58,655	41,175	17,480	575	16,905	16,905
1971-75	49,635	36,867	12,768	1,428	11,340	16,905
1972-76	49,805	37,109	12,696	1,445	11,251	16,905
1973-77	48,168	35,638	12,530	1,621	10,909	16,905
1974-78	47,987	35,086	12,901	1,712	11,189	16,905
1975-79	46,275	33,141	13,134	1,727	11,407	16,905
1976-80	40,878	31,930	8,948	1,338	7,610	16,905
1977-81	35,668	29,500	6,168	1,073	5,095	16,905
1978-82	33,390	28,889	4,501	694	3,807	16,905
1979-83	30,462	27,062	3,400	393	3,007	16,905
1980-84	32,255	29,279	2,976	310	2,666	16,905
1981-85	36,718	30,811	5,907	1,074	4,833	16,905
1982-86	40,405	32,287	8,118	1,880	6,238	16,905
1983-87	47,081	37,891	9,190	2,377	6,813	16,905
1984-88	55,898	44,741	11,157	2,732	8,425	16,905
1985-89	61,014	49,099	11,915	2,826	9,089	16,905
1986-90	68,436	57,508	10,928	2,430	8,498	16,905
1987-91	72,724	62,139	10,585	1,830	8,755	16,905
1988-92	76,299	66,153	10,146	1,492	8,654	16,905
1989-93	77,724	69,281	8,443	1,100	7,343	16,905
1990-94	79,434	72,134	7,300	896	6,404	16,905
1991-95	79,171	73,276	5,895	654	5,241	16,905
1992-96	81,888	77,379	4,509	526	3,983	16,905
1993-97	79,636	75,587	4,049	380	3,669	16,905
1994-98	75,631	71,695	3,936	412	3,524	16,905
1995-99	72,382	68,473	3,909	539	3,370	16,905

VERIFIED EXTRACTIONS FROM COLTON BASIN AREA  
BY SAN BERNARDINO AND RIVERSIDE COUNTY ENTITIES  
FOR USE IN EACH COUNTY  
FIVE-YEAR TOTALS  
(All Values in Acre-Feet)

Five-Year Period	Total from Basin	Extracted by San Bernardino County Entities	Extracted by Riverside County Entities		Base Right for Use in Riverside County	1
			Total	Used in San Bernardino County		
Five-Year Base Period 1959-63	58,655	41,175	17,480	575	16,905	16,905
1996-00	68,197	64,617	3,580	486	3,094	16,905
1997-01	67,546	64,288	3,258	576	2,682	16,905
1998-02	72,209	68,778	3,431	611	2,820	16,905
1999-03	86,893	82,665	4,228	597	3,631	16,905
2000-04	98,675	95,402	3,273	382	2,891	16,905
2001-05	104,366	101,292	3,074	312	2,762	16,905
2002-06	105,543	102,390	3,153	144	3,009	16,905
2003-07	107,370	104,870	2,500	28	2,472	16,905
2004-08	102,372	100,013	2,359	10	2,349	16,905
2005-09	101,562	99,004	2,558	3	2,555	16,905
2006-10	107,203	104,655	2,548	0	2,548	16,905
2007-11	110,210	107,901	2,309	0	2,309	16,905
2008-12	109,371	107,730	1,641	0	1,641	16,905
2009-13	109,713	108,930	783	0	783	16,905
2010-14						
2011-15						
2012-16						
2013-17						
2014-18						
2015-19						
2016-20						

*1 Extractions for use in Riverside County are limited to the verified extractions for the five-year Base Period 1959-63.*

*Note: Five-year totals corrected to reflect any corrections on Table 4, Page 1a of 2 and Page 1b of 2*

VERIFIED EXTRACTIONS FROM RIVERSIDE BASIN AREA  
 WITHIN SAN BERNARDINO COUNTY  
 BY SAN BERNARDINO AND RIVERSIDE COUNTY ENTITIES  
 FOR USE IN EACH COUNTY  
 ANNUAL TOTALS  
 (All Values in Acre-feet)

Calendar Year	Total from Basin	Extracted by San Bernardino County Entities		Extracted by Riverside County Entities							
				Total	Used in San Bernardino County	Used in Riverside County	Base Right for Use in Riverside County				
Five-Year Base Period 1959-63 Avg.	33,729	9,609		24,120	3,035	21,085	21,085				
1971	29,070	8,748		20,322	2,214	18,108	21,085				
1972	28,148	7,963		20,185	1,597	18,588	21,085				
1973	21,809	6,490		15,319	1,333	13,986	21,085				
1974	21,881	6,899		14,982	1,399	13,583	21,085				
1975	22,701	6,513		16,188	1,225	14,963	21,085				
1976	24,705	6,898		17,807	1,666	16,141	21,085				
1977	23,506	7,089		16,417	1,985	14,432	21,085				
1978	17,216	6,261		10,955	1,900	9,055	21,085				
1979	20,024	7,062		12,962	2,370	10,592	21,085				
1980	18,533	5,932	2	12,601	2	3,410	9,191	2	21,085		
1981	23,611	6,811		16,800	3,733	13,067	21,085				
1982	17,349	2	5,402	2	11,947	2	3,483	2	8,464	2	21,085
1983	11,904	2	5,204	2	6,700	2	2,925	2	3,775	2	21,085
1984	17,161		5,648		11,513		1,953		9,560		21,085
1985	19,392	2	6,048	2	13,344		2,143		11,201		21,085
1986	17,337		7,401	2	9,936	2	1,245		8,691	2	21,085
1987	15,803	2	7,374	2	8,429		717		7,712		21,085
1988	16,933	2	7,237	2	9,696	2	773		8,923	2	21,085
1989	25,557		7,781		17,776		1,619		16,157		21,085
1990	26,371		7,872		18,499		2,628		15,871		21,085
1991	28,011		6,472		21,539		2,984		18,555		21,085
1992	21,959	2	5,652	2	16,307		1,579		14,728		21,085
1993	21,866		5,428		16,438		1,735		14,703		21,085
1994	19,661		5,711		13,950		1,746		12,204		21,085
1995	23,865	2	6,223	2	17,642		1,696		15,946		21,085
1996	26,698	2	11,986	2	14,712		1,308	2	13,404	2	21,085
1997	30,284	2	17,887	2	12,397	2	1,358	2	11,039	2	21,085
1998	33,116		22,112		11,004	2	1,330	2	9,674	2	21,085
1999	35,482	3	21,899	3	13,583	2	1,867	2	11,716	2	21,085
2000	36,124	3,4	23,634	2-4	12,490	2	1,121	2	11,369	2	21,085

TABLE NO. 5  
 VERIFIED EXTRACTIONS FROM RIVERSIDE BASIN AREA  
 WITHIN SAN BERNARDINO COUNTY  
 BY SAN BERNARDINO AND RIVERSIDE COUNTY ENTITIES  
 FOR USE IN EACH COUNTY  
 ANNUAL TOTALS  
 (All Values in Acre-feet)

Calendar Year	Total from Basin	Extracted by					Used in San Bernardino County	Used in Riverside County	Base Right for Use in Riverside County		
		San Bernardino County Entities		Total	Riverside County Entities						
Five-Year Base Period 1959-63 Avg.	33,729	9,609			24,120	3,035	21,085	21,085			
2001	31,423	2-4	21,029	2,3	10,394	2	1,281	2	9,113	2	21,085
2002	28,042	3,4	13,926	3	14,116		2,441		11,675		21,085
2003	27,648	3,4	16,713	3	10,935		1,699	2	9,236	2	21,085
2004	24,779	3,4	15,558	3	9,221		2,499		6,722		21,085
2005	29,447	3,4	18,177	3	11,270		1,870		9,400		21,085
2006	30,045	2,3	16,037	2,3	14,008		1,139		12,869		21,085
2007	27,491	3	16,963	3	10,528		1,925		8,603		21,085
2008	30,678		16,097	2	14,581	2	1,447		13,134	2	21,085
2009	34,180		15,034	2	19,146	2	2,354		16,792	2	21,085
2010	29,125		13,793	2	15,332	2	2,657		12,675	2	21,085
2011	29,590		14,104		15,486		2,210		13,276		21,085
2012	29,137		11,457		17,680		2,067		15,613		21,085
2013	23,953		9,487		14,466		1,866		12,600		21,085
2014											
2015											
2016											
2017											
2018											
2019											
2020											

1 Extractions for use in Riverside County are limited to the verified extractions for five-year Base Period 1959-63.

2 Amounts corrected during a subsequent year verification of extractions.

Note: See Report of Watermaster, Volume 3, Tables 4 & 5; and Volume 5, Table 52-A.

3 Roquet, Harry V. reopened and filed 10 years of previous extractions for well recordation 3601422.

4 Arrowhead Regional Medical Center, new well 3603947, backfiled on First Notice.

TABLE NO. 5  
 VERIFIED EXTRACTIONS FROM RIVERSIDE BASIN AREA  
 WITHIN SAN BERNARDINO COUNTY  
 BY SAN BERNARDINO AND RIVERSIDE COUNTY ENTITIES  
 FOR USE IN EACH COUNTY  
 FIVE-YEAR TOTALS  
 (All Values in Acre-Feet)

Five-Year Period	Total from Basin	Extracted by San Bernardino County Entities	Extracted by Riverside County Entities		Base Right for Use in Riverside County	<i>1</i>
			Total	Used in San Bernardino County		
Five-Year Base Period 1959-63	168,645	48,045	120,600	15,175	105,425	105,425
1971-75	123,609	36,613	86,996	7,768	79,228	105,425
1972-76	119,244	34,763	84,481	7,220	77,261	105,425
1973-77	114,602	33,889	80,713	7,608	73,105	105,425
1974-78	110,009	33,660	76,349	8,175	68,174	105,425
1975-79	108,152	33,823	74,329	9,146	65,183	105,425
1976-80	103,984	33,242	70,742	11,331	59,411	105,425
1977-81	102,890	33,155	69,735	13,398	56,337	105,425
1978-82	96,733	31,468	65,265	14,896	50,369	105,425
1979-83	91,421	30,411	61,010	15,921	45,089	105,425
1980-84	88,558	28,997	59,561	15,504	44,057	105,425
1981-85	89,417	29,113	60,304	14,237	46,067	105,425
1982-86	83,143	29,703	53,440	11,749	41,691	105,425
1983-87	81,597	31,675	49,922	8,983	40,939	105,425
1984-88	86,626	33,708	52,918	6,831	46,087	105,425
1985-89	95,022	35,841	59,181	6,497	52,684	105,425
1986-90	102,001	37,665	64,336	6,982	57,354	105,425
1987-91	112,675	36,736	75,939	8,721	67,218	105,425
1988-92	118,831	35,014	83,817	9,583	74,234	105,425
1989-93	123,764	33,205	90,559	10,545	80,014	105,425
1990-94	117,868	31,135	86,733	10,672	76,061	105,425
1991-95	115,362	29,486	85,876	9,740	76,136	105,425
1992-96	114,049	35,000	79,049	8,064	70,985	105,425
1993-97	122,374	47,235	75,139	7,843	67,296	105,425
1994-98	133,624	63,919	69,705	7,438	62,267	105,425
1995-99	149,445	80,107	69,338	7,559	61,779	105,425



TABLE NO. 5  
 VERIFIED EXTRACTIONS FROM RIVERSIDE BASIN AREA  
 WITHIN SAN BERNARDINO COUNTY  
 BY SAN BERNARDINO AND RIVERSIDE COUNTY ENTITIES  
 FOR USE IN EACH COUNTY  
 FIVE-YEAR TOTALS  
 (All Values in Acre-Feet)

Five-Year Period	Total from Basin	Extracted by San Bernardino County Entities	Extracted by Riverside County Entities		Base Right for Use in Riverside County	1
			Total	Used in San Bernardino County		
Five-Year Base Period 1959-63	168,645	48,045	120,600	15,175	105,425	105,425
1996-00	161,704	97,518	64,186	6,984	57,202	105,425
1997-01	166,429	106,561	59,868	6,957	52,911	105,425
1998-02	164,187	102,600	61,587	8,040	53,547	105,425
1999-03	158,719	97,201	61,518	8,409	53,109	105,425
2000-04	148,016	90,860	57,156	9,041	48,115	105,425
2001-05	141,339	85,403	55,936	9,790	46,146	105,425
2002-06	139,961	80,411	59,550	9,648	49,902	105,425
2003-07	139,410	83,448	55,962	9,132	46,830	105,425
2004-08	142,440	82,832	59,608	8,880	50,728	105,425
2005-09	151,841	82,308	69,533	8,735	60,798	105,425
2006-10	151,519	77,924	73,595	9,522	64,073	105,425
2007-11	151,064	75,991	75,073	10,593	64,480	105,425
2008-12	152,710	70,485	82,225	10,735	71,490	105,425
2009-13	145,985	63,875	82,110	11,154	70,956	105,425
2010-14						
2011-15						
2012-16						
2013-17						
2014-18						
2015-19						
2016-20						

*1 Extractions for use in Riverside County are limited to the verified extractions for the five-year Base Period 1959-63  
 Note: Five-year totals corrected to reflect any corrections on Table 5, page 1 of 2*

### Minimum Groundwater Surface Elevations

Extractions from the Colton Basin Area and that portion of the Riverside Basin Area within San Bernardino County for use in San Bernardino Valley are not limited, provided that the average static groundwater surface elevation as measured at wells numbered 1S/4W-21Q03S, 1S/4W-29H01S, and 1S/4W-29Q01S is not less than 822.04 feet, as set forth in the Judgment. This elevation is determined each year by averaging the lowest static groundwater elevation occurring in each of the three wells at or near the same time of the year.

A map showing the locations and hydrographs of the calendar year 2013 static groundwater surface elevations in the three key wells are shown on the following pages. Data pertinent to the key wells as well as the records of historic water surface measurements are included in Report of Watermaster, Volume 8-2013 titled *Groundwater Surface Elevations in Wells Numbered 1S/4W-21Q03S, 1S/4W-29H01S, and 1S/4W-29Q01S Located Within the Colton Basin Area and Riverside Basin Area in San Bernardino County through December, 2013.*





The lowest static groundwater surface elevation measured in each of the three wells during calendar year 2013 is as follows:

<u>Well Number</u>	<u>Date of Measurement</u>	<u>Elevation of Water Surface</u>
1S/4W-21Q03S (Johnson #1)	December 2, 2013	872.72
1S/4W-29H01S (Flume #2)	December 2, 2013	820.75
1S/4W-29Q01S (Flume #5)	December 2, 2013	812.95
	Average	835.47

Thus, the lowest average fall water surface elevation for calendar year 2013 is 0.42 feet lower than the 2012 average of 835.89 and 13.43 feet higher than the 1963 average of 822.04.

# Map No. 2 Location of Key Wells

## Legend

-  Key Well
-  Colton Basin Area
-  Riverside Basin within San Bernardino County
-  San Bernardino Basin Area

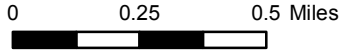

Y:\2014\1703\_SanBernardinoWesternWatermaster\MapNo2KeyWells.mxd

07/23/2014

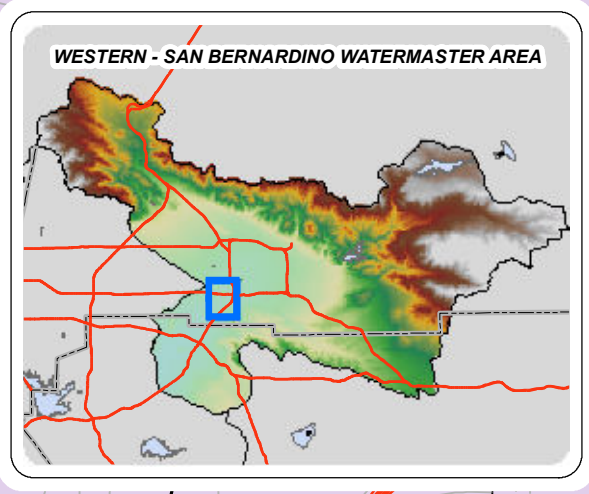
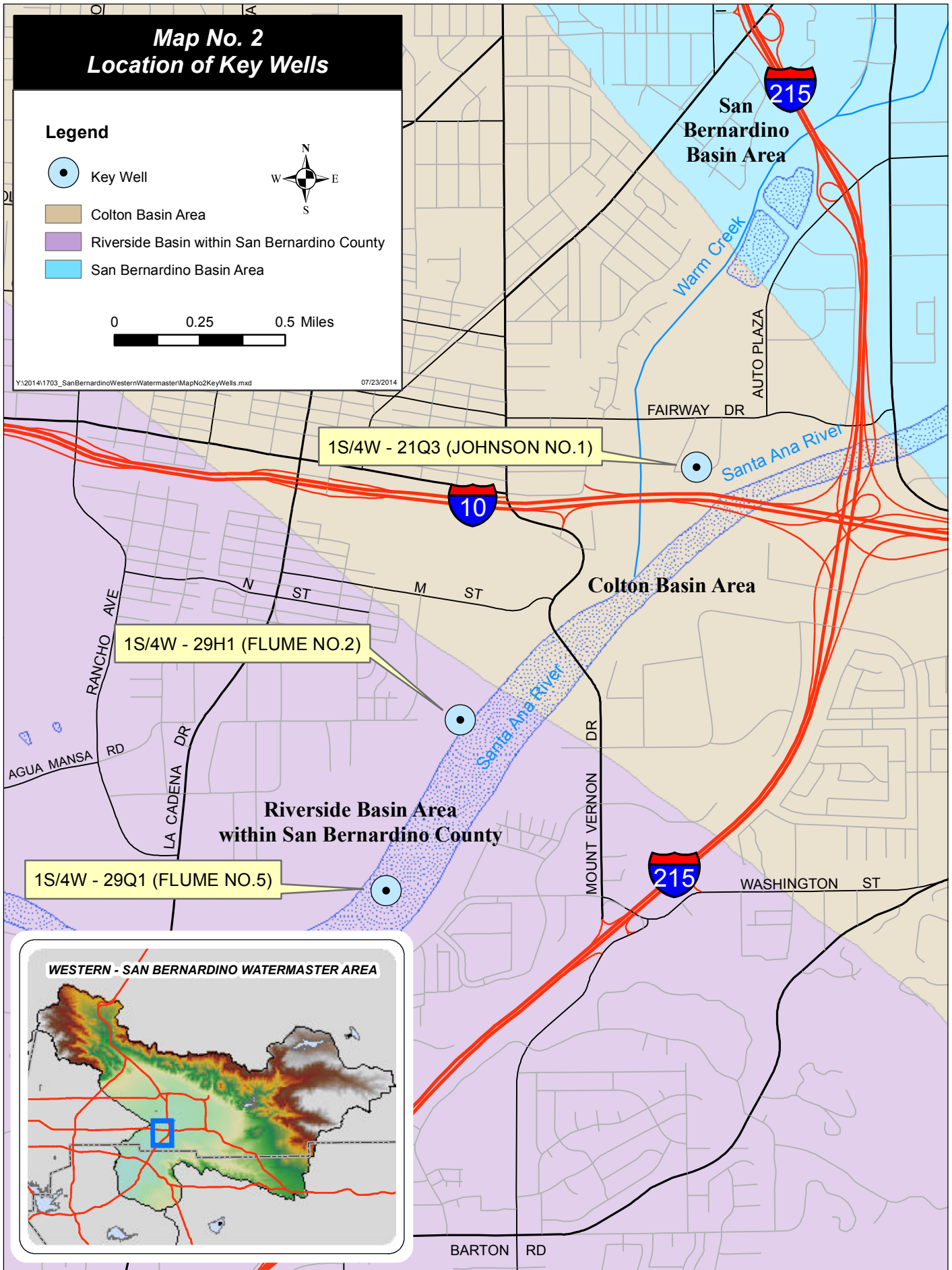

**FIGURE 1**  
**GROUNDWATER SURFACE ELEVATIONS**  
**1S/4W-21Q03S**  
**JOHNSON NO. 1 WELL**  
**2013**

08

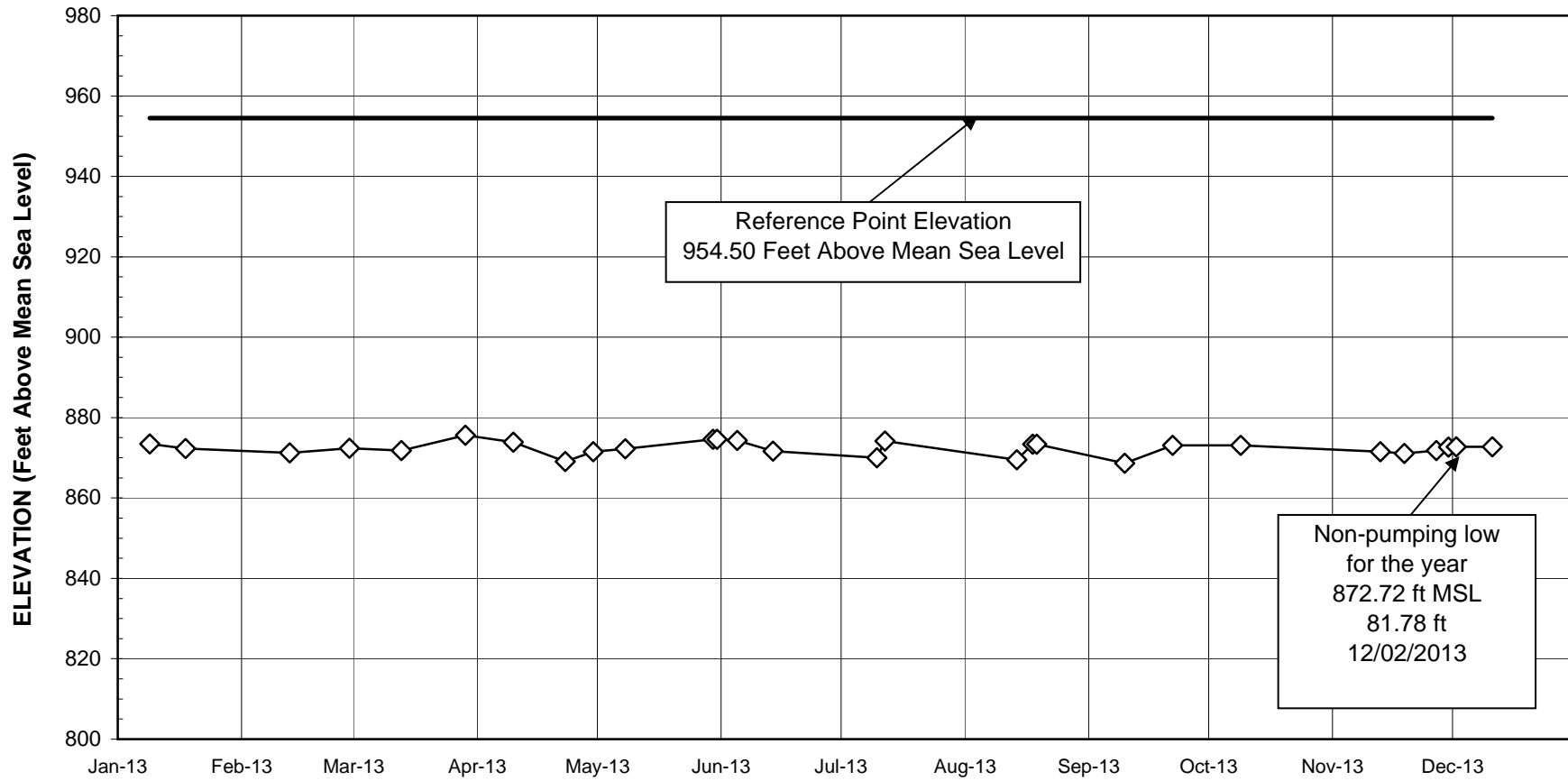

Non-pumping low  
for the year  
872.72 ft MSL  
81.78 ft  
12/02/2013

Reference Point Elevation  
954.50 Feet Above Mean Sea Level

**FIGURE 2  
GROUNDWATER SURFACE ELEVATIONS  
1S/4W-29H01S  
FLUME NO. 2 WELL  
2013**

81

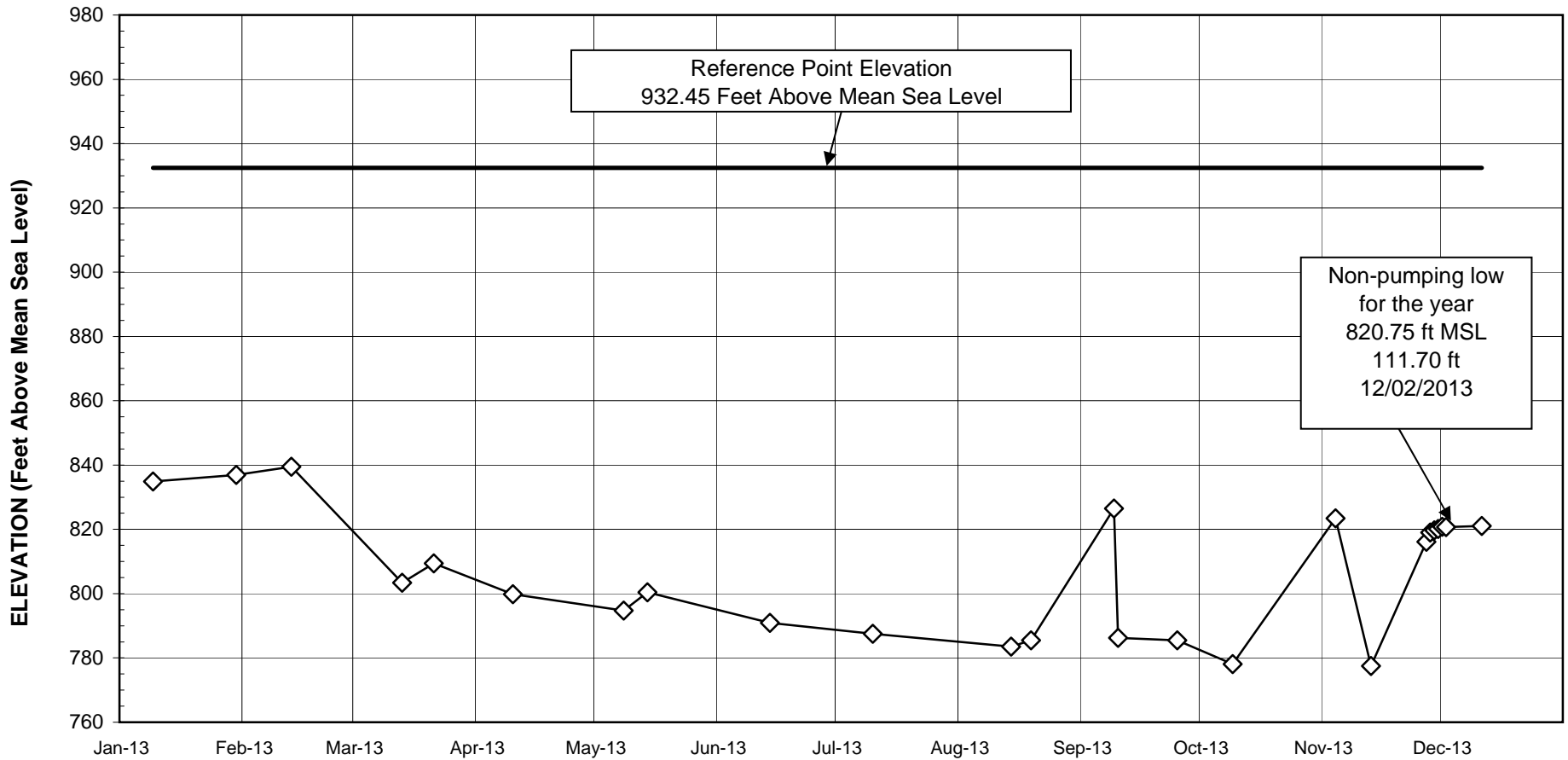

Reference Point Elevation  
932.45 Feet Above Mean Sea Level

Non-pumping low  
for the year  
820.75 ft MSL  
111.70 ft  
12/02/2013

**FIGURE 3**  
**GROUNDWATER SURFACE ELEVATIONS**  
**1S/4W-29Q01S**  
**FLUME NO. 5 WELL**  
**2013**

82

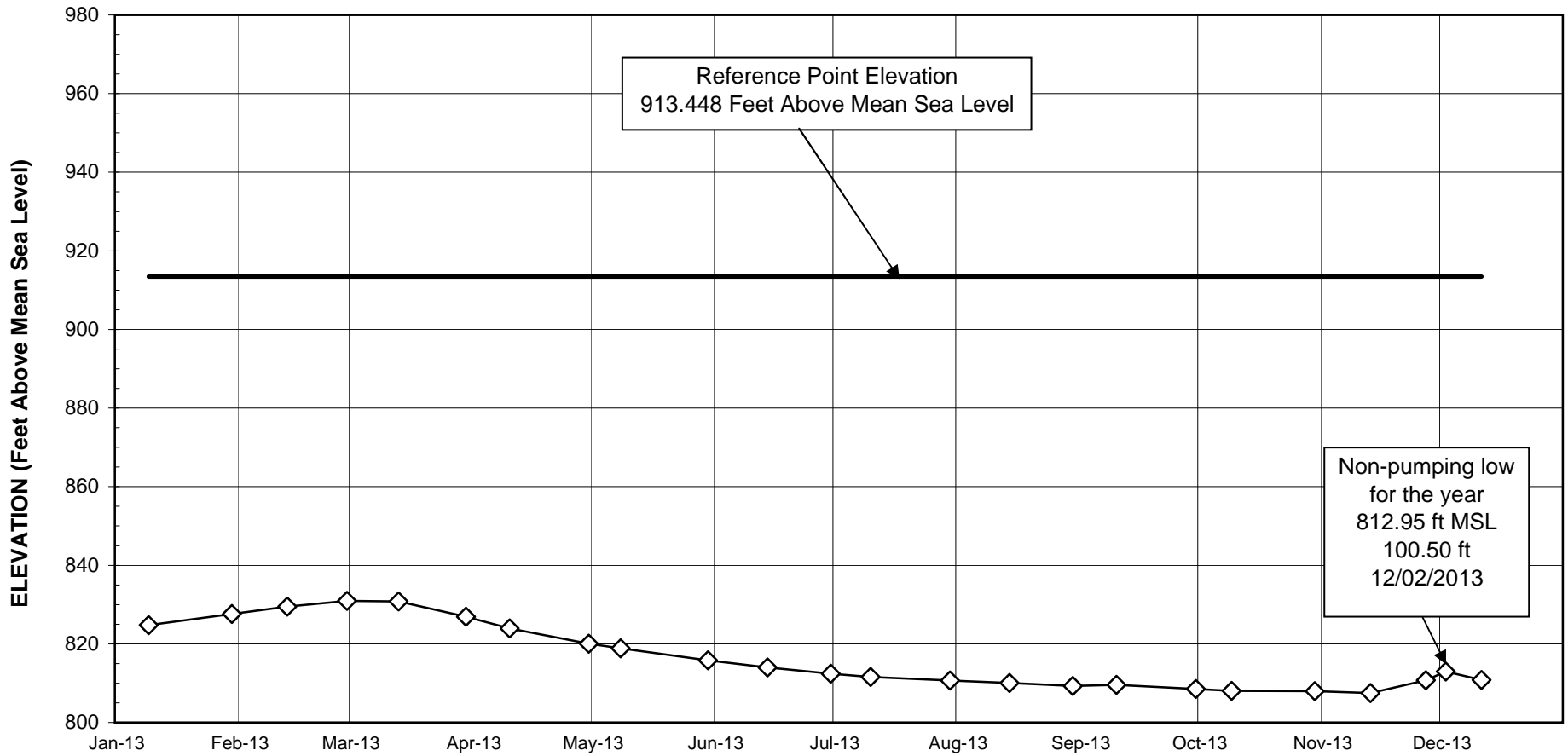

Non-pumping low  
for the year  
812.95 ft MSL  
100.50 ft  
12/02/2013

Reference Point Elevation  
913.448 Feet Above Mean Sea Level

**CHAPTER VI**

**EXTRACTIONS FROM THE PORTION OF  
RIVERSIDE BASIN AREA WITHIN RIVERSIDE COUNTY  
WHICH IS TRIBUTARY TO THE RIVERSIDE NARROWS**

## CHAPTER VI

### EXTRACTIONS FROM THE PORTION OF RIVERSIDE BASIN AREA WITHIN RIVERSIDE COUNTY WHICH IS TRIBUTARY TO THE RIVERSIDE NARROWS

#### Extractions

The extractions from that portion of the Riverside Basin area in Riverside County which is tributary to the Riverside Narrows for use within Riverside County for calendar year 2013 have been verified by the Watermaster as 30,070 acre-feet. The individual work sheets are included in Report of Watermaster, Volume 4-2013 titled *Verified Extractions from Riverside Basin Area Within Riverside County* and are summarized in Table No. 6 following.



TABLE NO. 6  
 VERIFIED EXTRACTIONS FROM RIVERSIDE BASIN AREA  
 WITHIN RIVERSIDE COUNTY  
 FOR USE IN RIVERSIDE COUNTY  
 ANNUAL TOTALS  
 (All Values in Acre-Feet)

Calendar Year	Total Extractions		Base Right for Use in Riverside County
Five-Year Base Period 1959-63 Avg.	29,633		29,633
1971	30,942	<i>1</i>	29,633
1972	37,804	<i>2</i>	29,633
1973	33,094		29,633
1974	38,304	<i>2</i>	29,633
1975	28,285		29,633
1976	31,565		29,633
1977	28,226		29,633
1978	24,576	<i>3</i>	29,633
1979	25,512		29,633
1980	30,206	<i>3</i>	29,633
1981	30,243	<i>3</i>	29,633
1982	20,365	<i>3</i>	29,633
1983	22,991	<i>3</i>	29,633
1984	32,466	<i>3</i>	29,633
1985	23,970	<i>3</i>	29,633
1986	24,549	<i>3</i>	29,633
1987	24,202	<i>3</i>	29,633
1988	24,470	<i>3</i>	29,633
1989	34,417	<i>3</i>	29,633
1990	31,760	<i>3</i>	29,633
1991	29,364	<i>3</i>	29,633
1992	26,538	<i>3</i>	29,633
1993	26,505		29,633
1994	28,125		29,633
1995	22,580		29,633
1996	24,906		29,633
1997	29,128		29,633
1998	28,558		29,633
1999	33,837		29,633
2000	32,263		29,633

TABLE NO. 6  
 VERIFIED EXTRACTIONS FROM RIVERSIDE BASIN AREA  
 WITHIN RIVERSIDE COUNTY  
 FOR USE IN RIVERSIDE COUNTY  
 ANNUAL TOTALS  
 (All Values in Acre-Feet)

Calendar Year	Total Extractions	Base Right for Use in Riverside County
Five-Year Base Period 1959-63 Avg.	29,633	29,633
2001	33,656	29,633
2002	31,013	29,633
2003	30,957	29,633
2004	35,530	29,633
2005	32,737	29,633
2006	31,026	29,633
2007	38,237    2,3	29,633
2008	31,205    3	29,633
2009	35,519	29,633
2010	29,077	29,633
2011	30,510    3	29,633
2012	28,049	29,633
2013	30,070	29,633
2014		
2015		
2016		
2017		
2018		
2019		
2020		

*1 Amount corrected during verification of 1972 extractions.*

*2 These extractions exceeded the Base Right plus peaking allowance of 20% by 2,244 acre-feet in 1972, 2,744 acre-feet in 1974 and 2,677 acre-feet in 2007*

*3 Amount corrected during subsequent year verification of extractions*

*Note: See Report of Watermaster, Volume 4, Table 4; Volume 5, Table 56.*

TABLE NO. 6  
 VERIFIED EXTRACTIONS FROM RIVERSIDE BASIN AREA  
 WITHIN RIVERSIDE COUNTY  
 FOR USE IN RIVERSIDE COUNTY  
 FIVE-YEAR TOTALS  
 (All Values in Acre-Feet)

Five-Year Period	Total Extractions	Base Right for Use in Riverside County
Five-Year Base Period		
1959-63	148,165	148,165
1971-75	168,429	148,165
1972-76	169,052	148,165
1973-77	159,474	148,165
1974-78	150,956	148,165
1975-79	138,164	148,165
1976-80	140,085	148,165
1977-81	138,763	148,165
1978-82	130,902	148,165
1979-83	129,317	148,165
1980-84	136,271	148,165
1981-85	130,035	148,165
1982-86	124,341	148,165
1983-87	128,178	148,165
1984-88	129,657	148,165
1985-89	131,608	148,165
1986-90	139,398	148,165
1987-91	144,213	148,165
1988-92	146,549	148,165
1989-93	148,584	148,165
1990-94	142,292	148,165
1991-95	133,112	148,165
1992-96	128,654	148,165
1993-97	131,244	148,165
1994-98	133,297	148,165
1995-99	139,009	148,165

TABLE NO. 6  
 VERIFIED EXTRACTIONS FROM RIVERSIDE BASIN AREA  
 WITHIN RIVERSIDE COUNTY  
 FOR USE IN RIVERSIDE COUNTY  
 FIVE-YEAR TOTALS  
 (All Values in Acre-Feet)

Five-Year Period	Total Extractions	Base Right for Use in Riverside County
Five-Year Base Period		
1959-63	148,165	148,165
1996-00	148,692	148,165
1997-01	157,442	148,165
1998-02	159,327	148,165
1999-03	161,726	148,165
2000-04	163,419	148,165
2001-05	163,893	148,165
2002-06	161,263	148,165
2003-07	168,487	148,165
2004-08	168,735	148,165
2005-09	168,724	148,165
2006-10	165,064	148,165
2007-11	164,548	148,165
2008-12	154,360	148,165
2009-13	153,225	148,165
2010-14		
2011-15		
2012-16		
2013-17		
2014-18		
2015-19		
2016-20		

*Note: 5-year totals corrected to reflect any corrections on Table 6, page 1 of 2*

## Return Flows

The Judgment provides for additional replenishment by Western if the urbanization of the Riverside Basin Area Within Riverside County results in a diminution of the return flow accruing from the extractions described above and which would have otherwise accrued to the rising water at Riverside Narrows. The extent of such diminution is determined by the permanent reduction in the irrigated areas within the various water service organizations delivering water to the areas as compared to the areas served at the time the Judgment was entered. To the extent that such reduction causes an increase in the urban uses requiring sewage disposal through the Riverside Treatment Plant (the effluent of which bypasses the Riverside Narrows), Western may, from time to time, be required to provide replenishment. Such irrigated acreages in the Riverside Basin Area Within Riverside County at the time the Judgment was entered, from which return flow was tributary to Riverside Narrows, are set forth in Table D-5 of Appendix "D" of the Judgment and are as follows:

IRRIGATED ACREAGE IN RIVERSIDE BASIN AREA  
IN RIVERSIDE COUNTY PRESENTLY TRIBUTARY TO  
RIVERSIDE NARROWS WHICH UPON CONVERSION  
TO URBAN USES REQUIRING SEWAGE DISPOSAL  
THROUGH THE RIVERSIDE TREATMENT PLANT WILL  
BE DISCHARGED TO THE RIVER BELOW  
RIVERSIDE NARROWS

<u>Entity Serving Acreage</u>	<u>Acres</u>
Gage Canal Company	1,752
Alta Mesa Water Company	65
East Riverside Water Company	926
Riverside Highland Water Company	<u>1,173</u>
TOTAL	3,916

The service areas of the companies listed in Table D-5 were investigated. Field investigation was not completed during calendar year 2014.

The number of dwelling units connected to the City of Riverside wastewater disposal system and a discharge unit factor of 0.22 acre-feet per year per dwelling unit was used to determine the wastewater discharged to the river from the converted lands. These data have been summarized for the years 2009 through 2013 and are shown on Table No. 7.

TABLE NO. 7  
 REDUCTION IN RETURN FLOW CONTRIBUTING TO BASE FLOW  
 AT RIVERSIDE NARROWS  
 RESULTING FROM CONVERSION OF AGRICULTURAL USES  
 OF WATER TO DOMESTIC USES CONNECTED TO A SEWAGE SYSTEM  
 DISCHARGING TO THE RIVER BELOW RIVERSIDE NARROWS  
 (All Values in Acre-Feet)

Calendar Year	Gage Canal	Alta Mesa	East Riverside	Riverside Highland	Total
2009	257	38	284	0	579
2010	257	38	284	0	579
2011	257	38	284	0	579
2012	257	38	284	0	579
2013	257	38	284	0	579
TOTAL	1,285	190	1,420	0	2,895

Table No. 7 shows that in 2013 the reduction in return flow contributing to Base Flow at Riverside Narrows resulting from the conversion of land from agricultural use to urban uses in the Riverside Basin Area was 579 acre-feet. Western's obligation associated with the land use conversion and resulting replenishment requirements are shown on Table No. 16.

## **CHAPTER VII**

**EXTRACTIONS FROM THE SAN BERNARDINO BASIN AREA,  
COLTON BASIN AREA, AND RIVERSIDE BASIN AREA  
FOR USE WITHIN WESTERN ON LANDS THAT ARE NOT  
TRIBUTARY TO THE RIVERSIDE NARROWS**

## CHAPTER VII

### **EXTRACTIONS FROM THE SAN BERNARDINO BASIN AREA, COLTON BASIN AREA, AND RIVERSIDE BASIN AREA FOR USE WITHIN WESTERN ON LANDS THAT ARE NOT TRIBUTARY TO THE RIVERSIDE NARROWS**

The extractions from the San Bernardino, Colton and Riverside Basin Areas which were delivered for use within Western on lands not tributary to the Riverside Narrows during calendar year 2013 were verified by the Watermaster to be 41,906 acre-feet. Said amount is summarized by entity on Table No. 8.

The detailed work sheets for this determination are contained in Report of Watermaster, Volume 6-2013, titled *Verified Extractions from the San Bernardino Basin Area, Colton Basin Area, and Riverside Basin Area for Use Within Western on Lands Not Tributary to the Riverside Narrows*.

#### **2013 and 2014 Annual Report Modifications Table No. 8**

During the period 1981 through 2004 agreements between Western and San Bernardino Valley were entered in all but four years to address the high groundwater problem in the San Bernardino Basin Area. It was agreed that there was an existing temporary surplus of natural groundwater supply in the Basin. Additional extractions were made available to Plaintiffs and users other than Plaintiffs in order to help mitigate the problem. The agreements also provided that the replenishment obligations in Judgment Paragraph X would not apply to such additional extractions.

Judgment Paragraph X provides that Western is obligated to provide an amount of replenishment equal to the loss of return flow from the export of water extracted by users from within Western and delivered for use on lands not



tributary to the Riverside Narrows that is in excess of the amount exported in the base period 1959 through 1963. Such excess is referred to as new export.

Table No. 8 is an accounting of the total export by entities within Western. Report of Watermaster, Volume 6 (referenced above) is the source of detailed worksheets for this determination.

In the reports for calendar years 1982 through 2011 the deduction of additional extractions from the San Bernardino Basin Area pursuant to the high groundwater mitigation agreements has been made in Column 15 of Table No. 1A in Report of Watermaster, Volume 6. In 2013, Volume 6 was modified by deleting the deduction in Table No. 1A and inserting the deduction in Annual Report Table No. 14. The new line in Table No. 14 is titled Additional New Export. This change was made to improve readability and understanding by causing Western's new export credit or obligation to be accounted for in a manner consistent with similar new export accounting for San Bernardino Valley.

In the reports for calendar years 1982 through 2011 the deduction of additional extractions pursuant to the high groundwater mitigation agreements by users other than Plaintiffs was accomplished through footnotes in Table No. 17. In order to make the table easier to read and understand, the data in the Table No. 17 footnotes were moved to Table No. 15A. The new line in Table No. 15A is also titled Additional New Export.

By eliminating the deduction of high groundwater agreement related additional extractions from Report of Watermaster, Volume 6, such extractions by Western users can now be deducted from total new export in Table No. 14 in the same way additional extractions by users other than Plaintiffs are deducted in Table No. 15A.

During the process of eliminating high groundwater related additional extractions from Report of Watermaster, Volume 6, and adding them to

Table No. 14, it was discovered that not all of the additional extractions had been deducted in Volume 6. As a result, the total additional extractions deducted in Table No. 14 are greater than the extractions deleted from Report of Watermaster, Volume 6.

In April 2014 the Report of Watermaster, Volume 6 was modified to include in Section II the determination of the amount of return flow from imported water used in Riverside County which contributes to base flow at Riverside Narrows. Western receives credit for such return flow against any future replenishment obligations pursuant to Judgment Paragraph XI(b)3. Judgment Paragraph XI(a) provides that the credit for return flow is the calculated amount of return flow adjusted upward or downward depending on the quality of the return flow, using the same quality adjustment formula used at Riverside Narrows as set forth in the Orange County Judgment.

There are currently two methods of delivering imported water in Riverside County to areas tributary to Riverside Narrows:

- 1) direct delivery to Western's retail service area and to the City of Riverside from the Henry J. Mills Treatment Plant which treats State Water Project water, or
- 2) delivery to Western or any Plaintiff party, groundwater from the San Bernardino Basin Area pursuant to the 2004 Judgment Paragraph VI(b)6 agreement that provides for 6,000 acre-feet of additional water extraction in exchange for Western's purchase of a like amount of recharge water.

From 1971 to 1978 direct deliveries, cited above as the first method, consisted of Colorado River Water and as a result, the amount of return flow was adjusted downward due to the high TDS concentration of the return flow. In 1979, low TDS State Water Project water became available to both Western and the

City of Riverside and therefore the return flow credit is greater than the actual return flow.

Using the second method cited above, in 2007 the City of Riverside extracted 2,459 acre-feet of the imported water recharge made available as additional water pursuant to the 2004 Judgment Paragraph VI(b)6 agreement referenced above. Prior to 2013, this additional water was deducted from export in Column 15, Table No. 1A of Report of Watermaster, Volume 6. In 2013, this additional extraction was also deleted from Volume 6 and inserted into Table No. 16 as a credit. The April 2014 modification causes the extraction to be a part of the determination of Return From Imported Water credit shown on Table No. 16.

Watermaster plans to further modify the Report of Watermaster, Volume 6, in the Calendar Year 2015 Annual Report to include the opportunity to calculate credit for Replenishment and Storm Flow Conservation including the quality adjustment and the obligation associated with Land Use Conversion. All of these determinations are used in determining Western's Net Accumulated (Credit) or Obligation in Table No. 16.

**TABLE NO. 8**  
**VERIFIED EXTRACTIONS FROM**  
**THE SAN BERNARDINO BASIN AREA,**  
**THE COLTON BASIN AREA, AND THE RIVERSIDE BASIN AREA**  
**FOR USE WITHIN WESTERN ON LANDS THAT ARE NOT TRIBUTARY**  
**TO THE RIVERSIDE NARROWS**  
**(All Values in Acre-Feet)**

Entities Within WMWD	Annual 1959-63 Average	Calendar Years				
		2009 Verified Delivery	2010 Verified Delivery	2011 Verified Delivery	2012 Verified Delivery	2013 Verified Delivery
City of Riverside, including Irrigation Division water extracted by the Gage Canal Company and former Riverside Water Company	23,836	32,365	31,155	33,415	34,412	35,390
Meeks & Daley Water Company, Agua Mansa Water Company, and Temescal Water Company, including water received from City of Riverside	13,229	5,096	5,178	5,473	3,721	4,161
Riverside Highland Water Company	0	0	0	0	0	386
Extractions delivered by West Riverside Canal received from Twin Buttes Water Company, La Sierra Water Company, Agua Mansa Water Company, Salazar Water Company, West Riverside 350 Inch Water Company, and Jurupa Water Company	4,903	533	475	456	503	516
Jurupa Community Services District	531	0	0	0	0	0
Rubidoux Community Services District	36	1,107	1,421	1,504	1,452	1,453
<b>TOTAL</b>	42,535	39,101	38,229	40,848	40,088	41,906

**Note: See Report of Watermaster, Volume 6, Table A.**

**CHAPTER VIII**

**EXTRACTIONS FROM THE  
SAN BERNARDINO BASIN AREA  
FOR USE ON LANDS NOT WITHIN WESTERN  
NOR TRIBUTARY TO THE RIVERSIDE NARROWS  
AND FOR USE ON LANDS WITHIN  
THE COLTON AND RIVERSIDE BASIN AREAS**

## CHAPTER VIII

### EXTRACTIONS FROM THE SAN BERNARDINO BASIN AREA FOR USE ON LANDS NOT WITHIN WESTERN NOR TRIBUTARY TO THE RIVERSIDE NARROWS AND FOR USE ON LANDS WITHIN THE COLTON AND RIVERSIDE BASIN AREAS

#### Deliveries to Chino Basin

Deliveries of extractions from the San Bernardino Basin Area for use on lands not within Western nor tributary to the Riverside Narrows (lands within Chino Basin) in amounts greater than deliveries in the 1959-63 base period results in a loss of return flow to the San Bernardino Basin Area. The amount delivered in the base period was 11,701 acre-feet.

The extractions from the San Bernardino Basin Area which were delivered for use on lands not within Western nor tributary to the Riverside Narrows (Chino Basin) during calendar year 2013 were verified by the Watermaster to be 15,559 acre-feet. Said amount is summarized by entity on Table No. 9A.

The detailed work sheets for this determination and for deliveries to areas other than Chino Basin and to the Colton and Riverside Basin Areas are contained in Report of Watermaster, Volume 7-2013, titled *Verified Extractions from the San Bernardino Basin Area for Use on Lands Not Within Western Nor Tributary to the Riverside Narrows and for Use on Lands Within the Colton and Riverside Basin Areas*.

#### Deliveries to Areas Other Than Chino Basin

The Judgment provides for replenishment by San Bernardino Valley to the extent exports are made from the San Bernardino Basin Area for use in the Yucaipa, San Timoteo, Oak Glen, and Beaumont Basins.

The results of the verification of the base period production from the San Bernardino Basin Area indicated that such exports were not made during the 1959-63 base period. The verification of production for the 2013 calendar year indicated that during 2013, no water was exported to the Yucaipa, San Timoteo, Oak Glen or Beaumont Basins.

#### **Deliveries to Lands Within the Colton and Riverside Basin Areas**

Deliveries of extractions from the San Bernardino Basin Area to the Colton and Riverside Basin Areas in amounts greater than deliveries in the 1959-63 base period also result in a loss of return flow to the San Bernardino Basin Area. The amount delivered in the base period was 17,837 acre-feet.

The extractions from the San Bernardino Basin Area, which were delivered for use on lands within the Colton and Riverside Basin Areas during calendar year 2013, were verified by the Watermaster to be 22,926 acre-feet. Said amount is summarized by entity on Table No. 9B.

#### **2013 and 2014 Annual Report Modifications Table Nos. 9A and 9B and Volume 7**

In 1992 the Court approved amendments to the Judgment that primarily addressed changes in the way calculations were made for export of extractions by users in San Bernardino County to areas not tributary to Riverside Narrows. Prior to 1992, the Judgment provided for replenishment of actual extractions in excess of the Adjusted Right pursuant to Paragraph VI(c). The Judgment also provided, in Paragraph X, for replenishment equal to the amount of extractions exported from the San Bernardino Basin Area to Chino Basin in excess of the amount exported in the base period 1959 through 1963. Such excess export is referred to as new export.

By 1990, it was apparent to Watermaster that the literal interpretation of Judgment Paragraphs VI(c) and X was resulting in a replenishment requirement greater than necessary to offset the loss of return flow to the San Bernardino Basin Area resulting from new export. This became an issue generally known as the “two-for-one” issue.

Considerable inquiry of those directly involved in the settlement was accomplished in an effort to determine if replenishment in excess of return flow loss was intentional. There was no evidence it was intentional. Nor was there any evidence anywhere else in the Judgment of a requirement to replenish amounts in excess of just the amount necessary to offset an adverse impact. In 1992, Watermaster began to refer to the necessity to offset adverse impacts with an equal amount of replenishment as maintenance of hydrologic integrity.

So, one of the 1992 amendments was to address the “two-for-one” issue. Two approaches were considered. The first consisted of amending Paragraph X to require replenishment equal to only the loss of return flow associated with the actual export (currently 36 percent). The second approach consisted of subtracting the new export from the total extractions before determining if extractions were greater than or less than the Adjusted Right. Both approaches resulted in the same determination of new export obligation and the obligation was equal to the adverse impact on groundwater storage of just the loss of return flow resulting from export. Hydrologic integrity of the basin was maintained with either approach.

The second approach referenced above consisting of subtracting new export from total extraction and treating all new export as an obligation was used to write the amendments and to correct the new export calculations. Corrections to the methodology used to calculate obligations related to new export were made in the August 1994 Watermaster Annual Report. Corrections to all prior



new export calculations were made back to 1971. The “two-for-one” issue was resolved.

Other amendments included in the 1992 Court order to preserve the hydrologic integrity of specific groundwater basins were:

- 1) Western’s obligation to replenish to offset exports by users within Western that exceeded the export in the base period was limited to just the amount necessary to offset the loss of return flow (currently 36 percent of new export). In 1994 changes to the calculation of Western’s new export credits or obligations were also made commencing in calendar year 1971 to reflect this amendment.
- 2) San Bernardino Valley’s obligation to replenish was changed to require separate accounting for the San Bernardino Basin Area (not including Colton Basin Area) in order to ensure hydrologic integrity of the Basin. No modifications were made in 1994 to address this matter. Modifications to the 2013 Annual Report addressed this provision of the 1992 amendment.
- 3) The addition of provisions that:
  - a) require replenishment in the Colton and Riverside Basins to offset loss of return flow related to increase in exports therefrom for use in areas not within Western nor tributary to Riverside Narrows, and
  - b) reduce any replenishment required by (a) above by providing credit for return flow resulting from water delivered directly in Colton and Riverside Basins that originates outside the Basins.

Modifications necessary to make these determinations were a part of the 2014 modifications. The determinations for (a) above are included in Volume 7,

Section IV, Chapter VII, Table K. Similarly, the determinations for (b) above are included in Report of Watermaster Volume 7, Section IV, Chapter VIII, Table L.

One of the purposes of this section in Chapter VIII is to describe in some detail the 2013 modifications in Report of Watermaster, Volume 7 and the resulting changes in Table Nos. 9A and 9B necessary to:

- 1) more accurately reflect the 1992 amendment described as amendment two above, and
- 2) preserve the hydrologic integrity of the San Bernardino Basin Area, as such integrity is affected by return flow from applied water.

Watermaster Annual Reports prior to 2013 described export of extractions for use in San Bernardino County from San Bernardino Valley as the sum of:

- 1) export from San Bernardino Basin Area and Colton Basin Area combined for delivery in Chino Basin, and
- 2) export from San Bernardino Basin Area for delivery in Yucaipa, San Timoteo, Oak Glen and Beaumont Basins.

Pursuant to the amended Judgment and the objective of maintaining the hydrologic integrity of the San Bernardino Basin Area, the 2013 modified Annual Report describes delivery of extractions from the San Bernardino Basin Area for use in San Bernardino County as:

- 1) export from San Bernardino Basin Area only for delivery to Chino Basin (Table No. 9A),
- 2) export from San Bernardino Basin Area for delivery to Yucaipa, San Timoteo, Oak Glen and Beaumont Basin's, referred to as areas other than Chino Basin (Table No. 9A), and
- 3) delivery from San Bernardino Basin Area for delivery use in Colton and Riverside Basin Areas (Table No. 9B).

The improvement in hydrologic integrity resulting from the 2013 modifications is demonstrated as follows:

- 1) by deleting the export from the Colton Basin Area to the Chino Basin from the determination of credits and obligations in the San Bernardino Basin Area, the obligations in the San Bernardino Basin Area are no longer overstated, and
- 2) conversely, by accounting for the deliveries from the San Bernardino Basin Area to the Colton and Riverside Basin Areas as the resulting loss of return flow to the San Bernardino Basin Area, the obligation in the San Bernardino Basin Area is not understated.

Therefore, the determination of the effects of new export to areas not tributary to the Riverside Narrows and new deliveries to the Colton and Riverside Basin Areas on storage in the San Bernardino Basin Area is more accurate.

The 2013 methodology used to determine export for delivery to Chino Basin from the San Bernardino Basin Area consists of:

- 1) the continuation of prior practice of calculating the export from San Bernardino Basin Area and Colton Basin Area, and
- 2) the determination of the export from San Bernardino Basin Area to Chino Basin only, using data from (1) above and other required information. The results of this calculation are now shown in the modified Table No. 9A.

The modifications to the calculation of export described in this section also included a redetermination of the annual average export during the 1959 through 1963 base period. The methodology for such redetermination was the same as for calendar years 1971 through 2011. The base period average amount for delivery to the export areas for each entity is shown in the first column of Table

No. 9A. Prior to modification the total base period average was 12,527 acre-feet. After modification, it decreased to 11,701 acre-feet, largely as a result of deleting export from Colton Basin Area and Riverside Basin Area to areas not within Western nor tributary to the Riverside Narrows.

The 2013 methodology used to determine deliveries to the Colton and Riverside Basin Areas is new. However, most of the necessary data is readily available in Report of Watermaster, Volumes 1 and 7. The results are shown in Table No. 9B.

The modifications relating to deliveries from the San Bernardino Basin Area to the Colton and Riverside Basin Areas in this section also included a determination of the annual average deliveries during the 1959 through 1963 base period. The base period average amount for delivery to the Colton and Riverside Basin Areas for each entity is shown in the first column of Table No. 9B. The total base period average is 17,837 acre-feet.

Report of Watermaster, Volume 7 was also modified to include a new section that includes:

- 1) Table No. 21 showing deliveries of imported water (State Water Project) for recharge in each groundwater basin and deliveries for direct use inside and outside San Bernardino Basin Area, and
- 2) Table No. 22 showing return flow from direct deliveries inside the San Bernardino Basin Area excluding direct deliveries of Big Bear Municipal Water District in-lieu deliveries.

The summation of these data has always been included in Table No. 17. However, the details shown in Section V of Report of Watermaster, Volume 7, were not published. Diagram No. 1, Organization of the Annual Report shows the imported water direct delivery and replenishment data flowing from Volume 7 to Table No. 17.

TABLE NO. 9A  
 VERIFIED EXTRACTIONS FROM THE  
 SAN BERNARDINO BASIN AREA  
 FOR USE ON LANDS NOT WITHIN WESTERN  
 NOR TRIBUTARY TO RIVERSIDE NARROWS

(All Values in Acre-Feet)

Entities	Annual 1959-63 Average	Calendar Years				
		2009 Verified Delivery	2010 Verified Delivery	2011 Verified Delivery	2012 Verified Delivery	2013 Verified Delivery
Fontana Union Water Company *	10,170	15,177	19,421	30,786	18,672	11,074
West Valley Water District (formerly WSBCWD)	1,314	5,592	4,508	3,001	3,374	3,406
City of Rialto	217	1,272	1,388	900	898	1,079
<b>Subtotal (Delivery to Chino Basin)</b>	<b>11,701</b>	<b>22,041</b>	<b>25,317</b>	<b>34,687</b>	<b>22,944</b>	<b>15,559</b>
San Bernardino Valley Municipal Water District <sup>1</sup>	0	0	0	0	0	0
<b>Subtotal (Delivery to areas other than Chino Basin)</b>	<b>0</b>	<b>0</b>	<b>0</b>	<b>0</b>	<b>0</b>	<b>0</b>
<b>TOTAL</b>	<b>11,701</b>	<b>22,041</b>	<b>25,317</b>	<b>34,687</b>	<b>22,944</b>	<b>15,559</b>

\* Fontana Water Company delivers water extracted from San Bernardino Basin Area and Colton Basin Area as Fontana Union Water Company. The Fontana Water Company water service area is located largely within Chino Basin. However, portions of the Fontana Water Company service area are within Colton Basin Area. Records of the deliveries within the Colton Basin Area are not available to the Watermaster.

<sup>1</sup> Water diverted from Mill Creek and delivered to Yucaipa Basin and water pumped through Central Feeder Project into Inland Feeder Project.

Note: See Report of Watermaster, Volume 7, Table Nos. C & D.

TABLE NO. 9B  
 VERIFIED EXTRACTIONS FROM THE  
 SAN BERNARDINO BASIN AREA  
 FOR USE ON LANDS WITHIN COLTON AND RIVERSIDE BASIN AREAS  
 (All Values in Acre-Feet)

Entities	Annual 1959-63 Average	Calendar Years				
		2009 Verified Delivery	2010 Verified Delivery	2011 Verified Delivery	2012 Verified Delivery	2013 Verified Delivery
Fontana Union Water Company	529 *	0	0	0	0	0
West Valley Water District (formerly WSBCWD)	11,172	9,692	5,909	6,855	6,793	7,345
City of Rialto	858	8,052	6,517	6,507	6,941	6,770
City of Colton	3,347	6,334	4,740	4,783	6,222	5,170
City of San Bernardino Elevated System	886	2,785	2,697	2,722	2,853	2,871
<u>Terrace Water Company</u>	<u>1,045</u>	<u>788</u>	<u>701</u>	<u>706</u>	<u>751</u>	<u>770</u>
TOTAL	17,837	27,651	20,564	21,573	23,560	22,926

*\* Fontana Water Company delivers water extracted from San Bernardino Basin Area and Colton Basin Area as Fontana Union Water Company. The Fontana Water Company water service area is located largely within Chino Basin. However, portions of the Fontana Water Company service area are within Colton Basin Area. Records of the deliveries within the Colton Basin Area are not available to the Watermaster.*

*Note: See Report of Watermaster, Volume 7, Table Nos. E & F.*

## **CHAPTER IX**

### **ANNUAL ACCOUNTING OF EXTRACTIONS, DELIVERIES, AND REPLENISHMENT OBLIGATIONS**



## CHAPTER IX

### **ANNUAL ACCOUNTING OF EXTRACTIONS, DELIVERIES, AND REPLENISHMENT OBLIGATIONS**

The Judgment requires the annual determination of extractions from the San Bernardino, Colton, and Riverside Basin Areas by Plaintiffs as well as Non-Plaintiffs, and further requires that a determination be made as to that portion of such extractions delivered to each of the service areas tributary to the Riverside Narrows as well as the deliveries to those areas not tributary to the Riverside Narrows.

#### **Plaintiff Extractions from San Bernardino Basin Area**

The Judgment specifically defines the Adjusted Right of the City of Riverside, Riverside Highland Water Company, Agua Mansa Water Company and Meeks & Daley Water Company, and The Regents of The University of California to extract water from the San Bernardino Basin Area for use in three specific service areas. Commencing in 2013, the Adjusted Rights include a part of each Plaintiff's proportionate share of new conservation. These rights, expressed in terms of the five-year total allowable extractions and deliveries and the maximum allowable extractions and deliveries in any one year for each service area, are shown on Table Nos. 10 through 13. These tables show the extractions for use by the Plaintiffs in the specific service areas and are summarized in the table on page 108.

During the period 2009 through 2013, each Plaintiff's extractions and delivery of such extractions to specific service areas did not exceed the five-year sum of the Adjusted Rights. Also, no Plaintiff exceeded the maximum allowable annual extraction for delivery to any service area in any year.

### **Allowable Plaintiff Extractions in 2014**

The Judgment limits Plaintiff's extraction in 2014 to the sum of the annual Adjusted Rights for the five year period 2010 through 2014 minus the actual extractions/deliveries in 2010 through 2013 or 1.3 times the Adjusted Right for 2014, whichever is the lessor. The Adjusted Rights include the portion of Seven Oaks related new conservation water forecast to result from increased recharge at the Santa Ana River Spreading Grounds.

The Judgment also provides in Paragraph VI(b)6 for agreements between San Bernardino Valley and Western under which additional extractions may be made from the San Bernardino Basin Area. Such agreements have been entered and approved by the Court to allow Plaintiffs the opportunity to extract water in addition to the limits cited in the paragraph above as follows:

1. Additional extractions resulting from recharge of imported water, including extraction of prior year under extractions in amounts equal to or less than the amount of right to extract imported water transferred from Western to Plaintiff minus any remaining balance of such amounts of under extraction.
2. Additional extractions resulting from Watermaster determination and allocation of specific amounts of Seven Oaks related new conservation water that resulted from increased recharge at the Santa Ana River Spreading Grounds from 1998 through 2012.

The portion of Seven Oaks related new conservation water that is not forecast to result from increased recharge at the Santa Ana River Spreading Grounds will probably be determined and allocated in the future by Watermaster as such conservation occurs through additional Court approved Judgment Paragraph VI(b)6 agreements. Such allocations will provide Plaintiffs with future

opportunities to extract more new conservation water than the amounts made available through their Adjusted Right.

Table Nos. 10A through 13A show each Plaintiffs allowable extractions for delivery to each service area for calendar year 2014. The first line of data on each table shows the allowable extractions based on Adjusted Right as described in the first paragraph of this section. The second line is the remaining balance in a Western imported water holding account (see Table Nos. 17B-1 through 17B-4) that is available for extraction as a result of Plaintiff under extractions as described in (1) above. The third line is the Plaintiffs remaining balance of any previous Watermaster allocations of new conservation water from years prior to 2013 plus any other allocation of new conservation water resulting from conservation in the San Bernardino Basin Area by means other than recharge at the Santa Ana River Spreading Grounds as described above.

#### **Non-Plaintiff Extractions from San Bernardino Basin Area**

The Judgment provides that the Non-Plaintiffs as a group can produce a specific amount of water from the San Bernardino Basin Area without causing San Bernardino Valley to replenish the Basin with imported water. During the period 2009 through 2013, the Non-Plaintiff Total Extractions exceeded San Bernardino Valley's Adjusted Right. However, pursuant to the 2013 Judgment Paragraph VI(b)6 agreement, new conservation water resulting from operation of Seven Oaks Reservoir from 1998 through 2012 was used to offset the Non-Plaintiff excess extractions in the amount of 17,815 acre-feet. Such use of new conservation water as shown in Table No. 17B-5 and Table No. 2, page 1b of 2 results in actual extractions equaling allowable extractions for Non-Plaintiffs as shown in the following table.

### **Total Extractions from the San Bernardino Basin Area**

A comparison of allowable extractions to actual extractions by Plaintiffs and Non-Plaintiffs for the period 2009 through 2013 is as follows:

	Allowable Extractions 2009-2013 (Acre-Feet)	Actual Extractions 2009-2013 (Acre-Feet)	Difference 2009-2013 (Acre-Feet)
Plaintiffs	326,446	287,571	(38,875)
Non- Plaintiffs	841,697	841,697	0
Total	1,168,143	1,129,268	(38,875)

### **Export to Areas Not Tributary to Riverside Narrows and Deliveries to Colton and Riverside Basin Areas**

The Judgment limits the amount of water that can be extracted from the various basins, without replenishment, for use on lands that are not tributary to the Riverside Narrows. The amounts delivered to the Colton Basin Area within San Bernardino Valley and Riverside Basin Area within San Bernardino County from the San Bernardino Basin Area, without replenishment, are also limited. Western and San Bernardino Valley are responsible for any obligation that may result from export or delivery to these areas in Riverside County and San Bernardino County, respectively.

Table Nos. 14 and 15A show the annual 1959-63 average export and actual export for use on lands in Riverside County and San Bernardino County not tributary to the Riverside Narrows. The high groundwater mitigation agreements regarding extraction of additional water provide that the Judgment Paragraph X provisions shall not apply to such additional water. Therefore, the additional water extracted by Plaintiffs and Non-Plaintiffs for export has been excluded from the determination of new export in the line titled Additional New Export on Table Nos. 14 and 15A, respectively.

Table No. 14 shows that during the period 1971 through 2013 the exports, excluding additional new export, by entities within Western was 323,686 acre-feet less than the allowable export. Table No. 15A shows that exports, excluding additional new export, from San Bernardino Basin Area exceeded the allowable export for the period 1971 through 2013 by 294,118 acre-feet. Western's credit and the obligation of San Bernardino Valley resulting from this new export are shown on Table Nos. 16 and 17, respectively.

Table No. 15B shows the annual 1959-63 average deliveries and actual deliveries for use on lands in Colton and Riverside Basin Areas. The table concludes that deliveries from the San Bernardino Basin Area to the Colton and Riverside Basin Areas during the period 1971 through 2013 exceeded the annual 1959-63 average deliveries for such period by 140,221 acre-feet. The San Bernardino Valley obligation resulting from these new deliveries is shown on Table No. 17.

### **Summary of Western Credits and Obligations**

Table No. 16 summarizes Western credits and obligations in the Colton Basin Area, Riverside Basin Area in San Bernardino County and Riverside Basin Area in Riverside County. The table shows the Base Right for extraction from each Basin Area and the extractions from each Basin Area for the period 2009 through 2013. The aggregate amount of under extractions or excess extractions resulting from such extractions are determined and included as either a credit or obligation along with other credits and obligations. The specific data inputs and logic used to determine each type of credit and obligation are described in subsection (3) on page 122 in the section titled 2013 and 2014 Annual Report Modification – Table Nos. 10 through 18.

The resulting net accumulated credit or obligation is the net accumulated credit or obligation from the period 1971 through 2008 plus the credit or

obligation for each year of the five-year period 2009 through 2013 for the Colton Basin Area, Riverside Basin Area in San Bernardino County and the Riverside Basin Area in Riverside County. The Judgment provides for such accumulation of credits and obligations. In summary, Table No. 16 shows that Western's net accumulated credit in the Colton and Riverside basins through 2013 is 454,393 acre-feet.

### **Summary of San Bernardino Valley Credits and Obligations**

Table No. 17 summarizes San Bernardino Valley credits and obligations in the San Bernardino Basin Area. The table shows the Adjusted Right for extraction and the actual extractions from the San Bernardino Basin Area by users in San Bernardino County for the period 2009 through 2013. The amount of under extractions or excess extractions resulting from such extractions are determined and included as either a credit or obligation along with other credits and obligations. The specific data inputs and logic used to determine each type of credit and obligation are described in subsection (3) on page 122 in the section titled 2013 and 2014 Annual Report Modifications – Table Nos. 10 through 18.

The resulting net accumulated credit or obligation is the net accumulated credit or obligation from the period 1971 through 2008 plus the credit or obligation for each year of the five-year period 2009 through 2013 for the San Bernardino Basin Area. The Judgment provides for such accumulation of credits and obligations. In summary, Table No. 17 shows that San Bernardino Valley's net accumulated credit in the San Bernardino Basin Area through 2013 is 163,154 acre-feet.

San Bernardino Valley may also incur an obligation in the Colton and Riverside Basin Areas within San Bernardino County. Chapter V indicates that extractions in the Colton and Riverside Basin Areas for use in San Bernardino

Valley are not limited provided that San Bernardino Valley maintains a specified minimum static water surface elevation in the three key wells in these basins. During the five-year period 2009 through 2013 the actual water surface elevation remained higher than the specified minimum. Therefore, San Bernardino Valley is not obligated to provide replenishment water for maintenance of these basins.

### **Annual Accounting of Additional Extractions**

As noted previously in this Chapter, Judgment Paragraph VI(b)6 provides that agreements may be entered between Western and San Bernardino Valley under which additional extractions may be made from the San Bernardino Basin Area. Three types of such additional extraction agreements which are existing or may be entered in the future are:

- 1) Additional Extractions of High Groundwater (existing) – Additional extraction of native water from the San Bernardino Basin Area declared to be a temporary surplus and made available for extraction, without replenishment, as part of the high groundwater mitigation program.
- 2) Additional Extractions of Imported Water (existing) – Additional extraction of water from the San Bernardino Basin Area by Western or any Plaintiff, after transfer, of imported water acquired by Western and recharged or extraction of prior year under extraction of Adjusted Rights in amounts not greater than the amount of right to extract imported water previously transferred from Western to Plaintiff minus any remaining balance of such amounts.
- 3) Additional Extractions of New Conservation Water – Additional extraction of Seven Oaks related new conservation water from the San Bernardino Basin Area resulting from either prior year

new conservation (existing) or future hydrologic events that yield large amounts of water that exceed the capacity to deliver and recharge water at the Santa Ana River Spreading Grounds (future). Such agreements also provide for an accounting of mitigation water set aside in the San Bernardino Basin Area to be used to mitigate the adverse effects of Seven Oaks related new conservation in the Riverside Basin Area.

Additional extractions of high groundwater were made in twenty years of the twenty-four year period 1981 through 2004. The accounting for such extractions and exports is accomplished in Table Nos. 2, 3, 14 and 15A as previously discussed.

The accounting for additional extractions of imported water, new conservation water and Riverside Basin Mitigation Account water from the San Bernardino Basin Area is accomplished in Table Nos. 17A, 17B-1 through 17B-5, and 17C respectively. These tables generally use the same format to account for additional extractions as is used in Table No. 17 to account for extractions from the San Bernardino Basin Area by users within San Bernardino County.

The significant difference between Table No. 17 and Table Nos. 17A, 17B, and 17C is that Table No. 17 is used to determine the amount of replenishment, if any, by San Bernardino Valley required to protect the rights of Plaintiffs against adverse effects of excess extractions from the San Bernardino Basin Area by other than Plaintiffs. Whereas, Table Nos. 17A, 17B and 17C are used to primarily determine, in any year, the remaining amount of any available additional extractions resulting from the replenishment of imported water or new conservation water made available pursuant to Judgment Paragraph VI(b)6 agreements or the remaining balance in the Riverside Basin Mitigation Account.



Table No. 17A, Imported Water

Additional extractions of imported water are available pursuant to Western's 2004 Paragraph VI(b)6 agreement. Western made an initial acquisition of 6,000 acre-feet of imported water in 2004. In 2007 Western transferred to City of Riverside the right to extract 2,459 acre-feet of imported water in order to address an excess extraction by Riverside. In 2009 Western acquired an additional 2,459 acre-feet of imported water from San Bernardino Valley. Therefore, in 2013, the amount of Western Net Accumulated Credit is 6,000 acre-feet.

In addition to accounting for imported water acquisitions, extractions by Western and transfers of the right to extract imported water to Plaintiffs, Table No. 17A accounts for the sum of all Plaintiff holding account transfers that result from implementation of Paragraph 11 of the 2013 Judgment Paragraph VI(b)6 agreement. Paragraph 11 provides that additional extractions of water are available to Plaintiffs in amounts not greater than Plaintiff's unused water right (under extraction) in any year after 2012 provided such amounts, plus any remaining balance of similarly acquired additional water, may not exceed Plaintiffs aggregate amount of previously transferred right to extract imported water.

Table No. 17A shows Plaintiff Transfers to Holding Accounts in 2013 in the amount of 2,459 acre-feet. This amount is the sum of the amounts in lines titled Imported Water Transfer to Holding Account in Table Nos. 17B-1 through 17B-4. The amount shown is only the amount shown in Table No. 17B-1 for City of Riverside because in 2013 only Riverside had previously acquired imported water and therefore was the only Plaintiff party with the opportunity to transfer under extractions into an imported water holding account. Table No. 17A shows in the line titled Imported Water Additional Extractions that no Plaintiff was either

capable of nor needed to withdraw water from holding accounts through additional extractions.

Table Nos. 17B-1 through 17B-5, New Conservation Water and Imported Water

Additional extractions of new conservation water resulting from new conservation in prior years are available to Plaintiffs and San Bernardino Valley pursuant to the 2013 Paragraph VI(b)6 agreement. The New Conservation Allocations shown on Table Nos. 17B-1 through 17B-5 are the amounts determined by Watermaster to have resulted from operation of Seven Oaks Reservoir during the prior years 1998 through 2012.

Any amounts of future new conservation determined by Watermaster to have resulted from the diversion of water conserved at Seven Oaks in addition to the amounts added to the Safe Yield Adjusted Rights in Table Nos. 2 (pages 1a & 1b) and 3A-1 through 3D-1 will likely be made available to Plaintiffs and San Bernardino Valley following the hydrologic event that caused such conservation and will also be included in the 17B tables as New Conservation Allocation. Extraction of any of the available New Conservation Allocation will be shown as Additional Extractions by other than Plaintiffs and Plaintiffs on Table Nos. 2 (pages 1a & 1b) and 3A-2 through 3D-2 respectively and on Table Nos. 17B-1 through 17B-5.

The amounts of additional extractions available for each Party are shown as New Conservation Net Accumulated (Credit) for 2013 on Table Nos. 17B-1 through 17B-5 and are equal to the amounts shown in the first data column of the table on page 28.

Paragraph 11 of the 2013 Judgment Paragraph VI(b)6 agreement provides that any Plaintiff may transfer to Western an amount of water equal to its unused water right in the San Bernardino Basin Area provided the remaining balance of such transfers may not exceed Plaintiffs aggregate amount of

previously transferred right to extract imported water. In addition to accounting for new conservation water, Table Nos. 17B-1 through 17B-4 also provide accounting for the imported water transfers and additional extractions resulting from implementation of Paragraph 11 as described above. Only the City of Riverside has previously received a transfer of right to extract from Western. Therefore, only Table No. 17B-1 shows transfers to a holding account in 2013.

Table No. 17B-1 shows the transfer of an under extraction by the City of Riverside to a holding account in the amount of 2,459 acre-feet in 2013. Such amount is equal to Western's previous transfer to Riverside of the right to extract 2,459 acre-feet needed to address an excess extraction by Riverside in 2007.

If in the future the City of Riverside over extracts water again, the 2,459 acre-feet in the holding account can be used to partially or entirely address the excess extraction. The amount of the transfer out of the holding account will be accounted for as an Imported Water Additional Extraction and will equal the amount of the excess extraction provided the excess extraction is not greater than the amount in the holding account. If the excess extraction is greater than the amount in the holding account, Riverside will likely acquire an additional right to extract from Western and Table No. 17B-1 will show the additional amount as an Imported Water Transfer From Western. Table No. 17B-1 will then show the Imported Water Additional Extractions as the sum of the Western transfer and the transfer from the holding account.

#### Table No. 17C, Riverside Basin Mitigation Account

As noted in Chapter III, page 31, a Judgment Paragraph VI(b)6 agreement approved by the Court in 2013, (2013 Agreement) provides for extraction of new conservation water resulting from operation of Seven Oaks Reservoir and the Santa Ana River Spreading Grounds from 1998 through 2012. The 2013 agreement also requires Watermaster to establish and maintain an accounting of

Seven Oaks related water conserved in the San Bernardino Basin Area that; in the absence of the Reservoir, would have been recharged in the Riverside Basin. The account is referred to as the Riverside Basin Mitigation Account and the accounting is provided in Table No. 17C.

Additions to the account consist of equal annual amounts resulting from the long term forecast of Seven Oaks related conservation at the Santa Ana River Spreading Grounds and specific year annual amounts that periodically result from Seven Oaks related conservation by means other than recharge at the Santa Ana River Spreading Grounds.

Mitigation of the adverse impact in the Riverside Basin is accomplished by extraction of the conserved water that has been included in or added to the Mitigation Account in a manner that effectively increases recharge and storage in the Riverside Basin. One method of accomplishing such mitigation is for the City of Riverside to increase extractions in the San Bernardino Basin Area and reduce extractions in the Riverside Basin by a like amount. Any such increase in extractions is shown on Table No. 17C as Extractions by the City of Riverside. A second mitigation method consists of extractions by other than Plaintiffs and subsequent delivery and recharge of such extractions in the Riverside Basin Area. Any such extraction can also be shown on Table No. 17C as Extractions by Other Than Plaintiffs.

The last line in Table No. 17C shows the Mitigation Account Balance in any year. The balance is the difference between the amounts included in the account (additions) pursuant to the 2013 Agreement and the sum of extractions by City of Riverside and other than Plaintiffs.

## **Summary of Compliance**

Table No. 18 addresses four basic questions regarding compliance with four general provisions of the Judgment. The first two provisions relate to the rights and obligations in the San Bernardino Basin Area. The last two provisions relate to obligations in the area between Bunker Hill Dike and the Riverside Narrows. The four general provisions are as follows.

- 1) The Judgment establishes water rights for Plaintiffs in the San Bernardino Basin Area and enjoins them from extracting from the Basin amounts greater than such right. So, the first question addressed in Table No. 18 is: “Did any Plaintiff’s extractions from the San Bernardino Basin Area for delivery to any service area exceed the maximum allowable?” Table No. 18 indicates that Plaintiff extractions from the Basin for delivery to any service area are less than the maximum allowable in 2013 and for the five-year period 2009 through 2013.
- 2) The Judgment provides users other than Plaintiffs the ability to extract unlimited amounts from the San Bernardino Basin Area and the freedom to manage the basin as they choose provided San Bernardino Valley replenishes the basin to offset any accumulated obligations determined pursuant to provisions of the Judgment. So, the second question addressed in Table No. 18 is: “Is San Bernardino Valley required to replenish the San Bernardino Basin Area?” Table No. 18 indicates that such replenishment is not required and that the amount of San Bernardino Valley credit that can be used to offset future obligations is 163,154 acre-feet in 2013.

- 3) Pursuant to the Orange County Judgment, San Bernardino Valley is obligated to deliver a specified amount of Base Flow in the Santa Ana River at Riverside Narrows. Extractions by users within Western between the Bunker Hill Dike and Riverside Narrows and other water management related activities within Western can adversely affect San Bernardino Valley's ability to meet its obligation at Riverside Narrows. The Judgment requires Western to replenish between the Bunker Hill Dike and Riverside Narrows in amounts necessary to offset any accumulated obligations determined pursuant to provisions of the Judgment, to ensure that San Bernardino Valley is not adversely affected by users within Western. So, the third question addressed in Table No. 18 is: "Is Western required to provide replenishment between the Bunker Hill Dike and Riverside Narrows?" Table No. 18 indicates that replenishment is not required and that the amount of Western credit that can be used to offset future obligations is 454,393 acre-feet in 2013.
- 4) Finally the Judgment provides San Bernardino Valley users in the Colton Basin Area and Riverside Basin Area in San Bernardino County the ability to extract unlimited amounts from those basins and the freedom to manage those basins and the San Bernardino Basin Area as they choose provided San Bernardino Valley replenishes the area below the Bunker Hill Dike sufficiently to maintain a prescribed average water level in three specific wells. So, the fourth question is: "Does San Bernardino need to provide replenishment to maintain

water levels downstream of the Bunker Hill Dike?”  
Table No. 18 indicates that such replenishment is not required and that for 2013 the average water level was 13.43 feet above the required minimum average level of 822.04 feet.

### **2013 and 2014 Annual Report Modifications Table Nos. 10 through 18**

Tables Nos. 10 through 18 are summary tables. As a result, the prior year data in all these tables is affected by the modifications discussed in Chapter III, Chapter VII and Chapter VIII. In addition to these data changes, the logic and layout of Table Nos. 10 through 18 have been changed to improve the readability, accuracy, and usefulness of the report. The following five subsections summarize the 2013 and 2014 modifications to these tables.

#### **1) Table Nos. 10 through 13**

Table Nos. 10 through 13 are used to address the first basic compliance question on Table No 18. The question is: “Did Extractions by Plaintiffs from the San Bernardino Basin Area for delivery to any service area exceed the maximum allowable?” There are thirty-two maximum allowable extraction or delivery amounts. Sixteen of them represent the maximum allowable in any year. The other sixteen represent the maximum allowable in any five-year period. (Sixteen equals four Plaintiffs times the total extraction plus three delivery areas.)

The modifications to Table Nos. 10 through 13 are relatively minor and do not affect the conclusions made in prior Annual Reports regarding Plaintiff compliance with provisions of the Judgment. However, the changes make the tables easier to read and understand.

As noted previously, any additional extractions made available pursuant to Judgment Paragraph VI(b)6 agreements need to be deducted from total extractions before determining compliance. Prior to 2013, the annual data in

Tables Nos. 10 through 13 included such additional extractions and the five-year data excluded it. The amounts of extraction included and excluded were incorporated in numerous footnotes. The tables were very confusing and difficult to understand and use.

The data related to additional extractions has been deleted from the footnotes on Table Nos. 10 through 13. Footnotes are still necessary; but, only for the purpose of documenting the specific Paragraph VI(b)6 agreement that provides for exclusion of additional extractions from the determination of compliance.

The additional extractions are now included in columns on Table Nos. 3A-2 through 3D-2 in Chapter III. In these tables the additional extractions are subtracted from total extractions and the result is shown as extractions. These extraction amounts, excluding additional extractions, are used to generate compliance Table Nos. 10 through 13.

In the August 1, 2014 Annual Report, Paragraph 11 of the 2013 Judgment Paragraph VI(b)6 agreement was implemented. In order to account for the transfer of an under extraction in the amount of 2,459 acre-feet by the City of Riverside in 2013 to a holding account in Table Nos. 17B-1 and 17A as permitted under Paragraph 11, the amount of the transfer is shown as a negative additional extraction in Table No. 3A-2 (page 2 of 3). As a result the deliveries by the City of Riverside for use outside San Bernardino Valley shown in Table No. 10 (pages 1c and 2b of 2) are greater than the actual deliveries by the amount of the 2,459 acre-feet transfer to the holding account.

Also in 2014, Table Nos. 10A through 13A were added to show allowable Plaintiff extractions for calendar year 2014. Reference the new section of this chapter on page 106 where 2014 allowable extractions are discussed.



2) Table Nos. 14, 15A and 15B

Table Nos. 14 and 15A are used to determine new export by Western and San Bernardino Valley respectively. The determination is made by first subtracting the annual 1959-63 average export from the current year actual export. That amount is referred to as Total New Export. Then, the additional extractions made available to Plaintiffs and San Bernardino Valley pursuant to the high groundwater mitigation Paragraph VI(b)6 agreements are subtracted from Total New Export. The resulting determination of New Export is used in determining credit or obligation for Western and San Bernardino Valley in Table Nos. 16 and 17.

Prior to 2013, the additional new export now shown in Table No. 14 was subtracted from export in Table No. 1A of Report of Watermaster, Volume 6 as described in Chapter VII. The additional new export now shown in Table No. 15A was previously subtracted from new export in Table No. 17 and documented using footnotes that included the specific amounts of such additional new export.

The deduction of additional new export related to high groundwater mitigation is now more clearly shown in Table Nos. 14 and 15A. Only additional new export associated with the high groundwater mitigation program is deducted in Table Nos. 14 and 15A.

Table No. 15B is used to determine new deliveries from the San Bernardino Basin Area by users in San Bernardino County to lands within the Colton and Riverside Basin Areas. The determination is made by first subtracting the annual 1959-63 average deliveries from the current year actual deliveries to determine Total New Deliveries. Then, pursuant to the high groundwater mitigation Paragraph VI(b)6 agreements, the allowable amounts of Additional New Deliveries are subtracted from Total New Deliveries to determine

New Deliveries for ultimate use in determining credit or obligation for San Bernardino Valley in Table No. 17.

3) Table Nos. 16 and 17

Table Nos. 16 and 17 are used to address the second and third basic compliance questions. Table No. 16 addresses the question: "Is Western required to replenish the Colton and Riverside Basin Areas?" Table No. 17 addresses the same question regarding San Bernardino Valley's obligation to replenish the San Bernardino Basin Area.

Table Nos. 16 and 17 are very important and very complex. Each table is the culmination of an extensive series of calculations that are complex largely because of the necessity to track return flow from applied natural safe yield water, imported water and new conservation water.

Diagram No. 1, Organization of Annual Report on page 19 shows that the ultimate source of data for Table No. 16 is Report of Watermaster, Volumes 1A through 6. The data inputs are:

- a) extractions from the Colton and Riverside Basin Areas by users within Western,
- b) new export resulting from delivery of extractions from all basins by Western users to areas not tributary to Riverside Narrows,
- c) replenishment of imported water,
- d) storm flow conservation between Bunker Hill Dike and Riverside Narrows by works financed by Western entities,
- e) increase in return flow to Riverside Narrows from direct delivery of imported water and imported water recharged in and extracted from the San Bernardino Basin Area by Western pursuant to Judgment Paragraph VI(b)6 agreements,

- f) return from use of new conservation water extracted by Plaintiffs, and
- g) decrease in return flow resulting from conversion of land use from agriculture to urban in a specified area within Western.

Table No. 16 shows the amount of credit or obligation resulting from each of these input activities in terms of how each transfer of water associated with each activity affects storage in the groundwater basins between Bunker Hill Dike and Riverside Narrows and thereby partially affects Base Flow at the Riverside Narrows. A credit indicates a potential increase in storage or Base Flow and an obligation indicates a potential decline in storage or Base Flow. A net accumulated obligation indicates that Western may be required to replenish the basins with imported water, subject to certain specific Judgment provisions.

The ultimate source of data inputs for Table No. 17 is Report of Watermaster, Volumes 1 and 7. The data inputs are:

- a) extractions from the San Bernardino Basin Area by users other than Plaintiffs,
- b) new export resulting from delivery of extractions from the San Bernardino Basin Area by users from within San Bernardino County to areas not tributary to the Riverside Narrows,
- c) new deliveries resulting from deliveries of extractions from the San Bernardino Basin Area by users from within San Bernardino County to the Colton Basin Area within San Bernardino Valley and Riverside Basin Areas within San Bernardino County.
- d) replenishment of imported water,

- e) return flow resulting from direct delivery of imported water by users in the San Bernardino Valley, and
- f) return from use of new conservation water extracted by users within San Bernardino Valley.

Table No. 17 shows the amounts of credit or obligation associated with each activity similar to that described for Table No. 16. A net accumulated obligation in Table No. 17 indicates a requirement for San Bernardino Valley to provide replenishment.

The 2013 and 2014 modifications to Table Nos. 16 and 17 are numerous. Because the tables are the culmination of data from many other tables, most of the modifications in other parts of the report affect amounts shown in these tables. So, the credits, obligations and net accumulated credit data may be different for years prior to 2013. These data are also different as a result in changes in the logic used to generate the tables.

During preparation of the calendar year 2011 Annual Report filed with the Court in August 2012, Watermaster became concerned about the logic used in Table Nos. 16 and 17. As a result these tables were incomplete and a commitment was made to resolve the concern. The 2013 and 2014 modifications include a resolution of the concern referenced in the August 2012 report.

The logic issue stems from uncertainty regarding the definition of a credit or obligation in Table Nos. 16 and 17. A credit or obligation can be defined in two ways. First, an amount of credit or obligation may be defined as the amount of under extraction (actual extraction less than allowable) or excess extraction (actual extraction greater than allowable). Second, a credit or obligation may be equal to the amount by which storage in the basin changes (positively or negatively) as a result of activity represented by the line of data in the table.

After thorough analysis, it has been determined that prior to the 2013 modifications some of the activities in Table Nos. 16 and 17 were based on the first definition and others on the second. The calculations related to excess extractions and under extractions were made using the first definition. All other determinations were made on the basis of the second definition.

The difference between results using the two definitions can be significant where use of the extraction is in the overlying basin and there is return flow to the basin. For example, if there is excess pumping of 15,000 acre-feet, one-third of the excess extraction or 5,000 acre-feet may return to the basin resulting in a loss of storage of only 10,000 acre-feet. Conversely, if an under extraction of the same amount occurs, the basin storage only increases by 10,000 acre-feet because failure to pump the 15,000 acre-feet results in a loss of return flow of 5,000 acre-feet.

Watermaster recognized the need for a consistent definition and chose the second definition largely because determinations based on how water transfers affect storage in the San Bernardino Basin Area would enable comparisons between Watermaster calculation of change in groundwater storage based on average hydrology (safe yield) to calculations of actual change in storage based on change in water level resulting from real hydrology. Therefore, Table Nos. 16 and 17 have been modified to cause all determinations for all water transfers or activities to be equal to the amount by which storage in the basin or Base Flow at the Riverside Narrows is affected by the activity.

Extractions from the Colton and Riverside Basin Areas by users within San Bernardino Valley are not included in Table 16. Such extractions also potentially affect storage or Base Flow at the Riverside Narrows. Therefore, extractions by users within Western are not the only factor affecting storage and

Base Flow and are only partially responsible for any change in storage or Base Flow at Riverside Narrows.

In addition to the logic changes necessary to be consistent in defining credits and obligations, several other modifications to Table Nos. 16 and 17 were made as follows:

Table No. 16

- a) Based on the Judgment provision that allows under extractions in one basin to offset excess extractions in another basin, the Base Rights and extractions for the Colton Basin Area, Riverside Basin Area within San Bernardino County and Riverside Basin Area within Riverside County have been consolidated into Total Base Right and Total Extractions. From 1992 through 2010, accounting for each basin was separate and, as a result, there was no mechanism within the tables to address excess extractions by using under extractions in an adjacent basin.
- b) New Export is subtracted from Total Extractions before determining if there are excess extractions or under extractions pursuant to the amended Judgment Paragraph VI(c)3. This prevents the “two-for-one” issue from recurring.
- c) The full amount of new export is shown as an obligation pursuant to Judgment Paragraph X.
- d) Return from Excess Extractions and Return from Under Extractions are included as credits and obligations in order to determine the partial effect of excess extractions and under extractions on Base Flow at the Riverside Narrows.

- e) New Export credits and obligations from Table No. 14 have been added to Table No. 16 so that the net accumulated credit includes all credits available to offset excess extractions. In Annual Reports prior to 2010 it was necessary to add the credits in Table No. 14 to the credits in Table No. 16 to determine total credits.
- f) A line has been added to enter amounts of replenishment of imported water. None has been replenished to date but could be in the future.
- g) A line has been added to enter amounts of storm flow conservation in the Colton and Riverside Basin Areas through facilities constructed and operated by Western entities.
- h) A line has been added to enter return from new conservation. Like imported water, the return flow from new conservation is not a component of the natural yield and therefore is available for extraction. Adding the return component (36 percent) as a credit makes it available for use without replenishment.

Table No. 17

- a) Modifications b, c, d, and h described above for Table 16 were also made in Table No. 17.
- b) Table 17 also has additional modifications to account for new deliveries of extractions from San Bernardino Basin Area to the Colton and Riverside Basin Areas.

4) Table Nos. 17B-1 through 17B-5 and 17C

In 2013 Table Nos. 17B-1 through 17B-5 were added to the Annual Report to account for the new conservation water resulting from operation of Seven Oaks Reservoir and related diversion and spreading facilities.

The tables show the amounts of new conservation allocated for use by each Plaintiff and entities in San Bernardino County other than Plaintiffs, the amounts extracted and the remaining balance in the account described as (Credit).

In the April 1, 2014 Annual Report Table No. 17C was added to account for water in the Riverside Basin Mitigation Account. The table shows additions to the account in the form of annual average amounts resulting from long term forecasts of new conservation and specific year amounts resulting from single year events that result in new conservation not accounted for in the long term forecast of annual average amounts. The table also shows extractions and the resulting account balance in any year commencing in 2013.

In the August 1, 2014 Annual Report, Table Nos. 17A and 17B-1 through 17B-4 were modified to provide a mechanism to account for transfer of imported water from Plaintiff to Western pursuant to Paragraph 11 of the Judgment Paragraph VI(b)6 agreement. Reference pages 113-115 for a description of the modified tables.

5) Table No. 18

The original intent of Table No. 18 in the Annual Report for calendar year 1976 was:

- a) to show whether or not Plaintiffs had exceeded their rights to extract from the San Bernardino Basin Area, and
- b) to show the amount of replenishment required by Western and/or San Bernardino Valley.



Since a Court of Appeals found the entire watershed to be in overdraft prior to filing of complaints that led to the settlement in 1969, the expectation at the time was that replenishment water would be required routinely. That has not proven to be the case. In fact, neither district has ever been required to provide replenishment. Plaintiffs have also incurred very few violations. Out of a potential for over 1,200 possible violations (42 years times 32 potential violations per year) very few have occurred.

In the years following 1976, Table No. 18 evolved into a much more detailed statement of credits and obligations for individual basins. Recently the table did not reflect the ability for under extractions to offset excess extractions by users within Western in the Colton and Riverside Basin Areas. The table implied that there could be a need for replenishment where none is required. Hence, during preparation of the Annual Report for calendar year 2012, Watermaster concluded that Table No. 18 was no longer an effective means of summarizing compliance with the general provisions of the Judgment as it was in 1976.

After considerable experimentation and review of alternative Table No. 18 designs, Watermaster selected a new design that is very consistent with the original intent in 1976. The resulting modified Table No. 18 is designed to directly address, and only address, in a concise, accurate, and easy to understand manner, the four basic questions regarding compliance with four general provisions of the Judgment. The modified Table No. 18, showing the responses to the four basic questions for calendar year 2014, is described in the Summary of Compliance on page 117.

TABLE NO. 10  
 ANNUAL ACCOUNTING OF EXTRactions BY THE CITY OF RIVERSIDE  
 FROM THE SAN BERNARDINO BASIN AREA  
 FOR DELIVERY TO EACH SERVICE AREA  
 (Including those rights acquired as successor to the  
 Riverside Water Company and the Gage Canal Company)  
 ANNUAL TOTALS  
 (All Values in Acre-Feet)

Calendar Year	Verified Extractions from the San Bernardino Basin Area			Delivery for Use in San Bernardino Basin Area			Delivery for Use in Colton Basin Area and Riverside Basin Area in San Bernardino County			Delivery for Use in Areas Outside San Bernardino Valley		
	Adjusted Right <sup>1</sup>	Maximum Allowable <sup>2</sup>	Extractions <sup>3</sup>	Adjusted Right <sup>4</sup>	Maximum Allowable <sup>2</sup>	Deliveries <sup>3</sup>	Adjusted Right <sup>4</sup>	Maximum Allowable <sup>2</sup>	Deliveries <sup>3</sup>	Adjusted Right <sup>1</sup>	Maximum Allowable <sup>2</sup>	Deliveries <sup>3</sup>
1971	53,448	69,482	53,882	1,462	1,901	98	1,260	1,638	669	50,726	65,944	53,115
1972	52,199	67,859	45,694	1,427	1,855	85	1,230	1,599	547	49,542	64,405	45,062
1973	52,199	67,859	43,022	1,427	1,855	156	1,230	1,599	512	49,542	64,405	42,354
1974	52,199	67,859	43,367	1,427	1,855	0	1,230	1,599	550	49,542	64,405	42,817
1975	52,199	67,859	47,962	1,427	1,855	0	1,230	1,599	498	49,542	64,405	47,464
1976	52,199	67,859	51,374	1,427	1,855	0	1,230	1,599	523	49,542	64,405	50,851
1977	52,199	67,859	50,999	1,427	1,855	0	1,230	1,599	346	49,542	64,405	50,653
1978	52,199	67,859	45,384	1,427	1,855	646	1,230	1,599	301	49,542	64,405	44,437
1979	52,199	67,859	52,377	1,427	1,855	0	1,230	1,599	415	49,542	64,405	51,962
1980	52,199	67,859	50,756	1,427	1,855	383	1,230	1,599	0	49,542	64,405	50,373
1981	52,199	67,859	51,009	1,427	1,855	724	1,230	1,599	0	49,542	64,405	50,285
1982	52,199	67,859	49,599	1,427	1,855	162	1,230	1,599	0	49,542	64,405	49,437
1983	52,199	67,859	45,988	1,427	1,855	335	1,230	1,599	0	49,542	64,405	45,653
1984	52,199	67,859	49,574	1,427	1,855	32	1,230	1,599	0	49,542	64,405	49,542
1985	52,199	67,859	49,601	1,427	1,855	59	1,230	1,599	0	49,542	64,405	49,542
1986	52,199	67,859	49,979	1,427	1,855	437	1,230	1,599	0	49,542	64,405	49,542
1987	52,199	67,859	49,876	1,427	1,855	334	1,230	1,599	0	49,542	64,405	49,542
1988	52,199	67,859	50,311	1,427	1,855	815	1,230	1,599	0	49,542	64,405	49,496
1989	52,199	67,859	50,784	1,427	1,855	28	1,230	1,599	0	49,542	64,405	50,756
1990	52,199	67,859	47,637	1,427	1,855	19	1,230	1,599	0	49,542	64,405	47,618

130

TABLE NO. 10  
 ANNUAL ACCOUNTING OF EXTRactions BY THE CITY OF RIVERSIDE  
 FROM THE SAN BERNARDINO BASIN AREA  
 FOR DELIVERY TO EACH SERVICE AREA  
 (Including those rights acquired as successor to the  
 Riverside Water Company and the Gage Canal Company)  
 ANNUAL TOTALS  
 (All Values in Acre-Feet)

Calendar Year	Verified Extractions from the San Bernardino Basin Area			Delivery for Use in San Bernardino Basin Area			Delivery for Use in Colton Basin Area and Riverside Basin Area in San Bernardino County			Delivery for Use in Areas Outside San Bernardino Valley		
	Adjusted Right <sup>1</sup>	Maximum Allowable <sup>2</sup>	Extractions <sup>3</sup>	Adjusted Right <sup>4</sup>	Maximum Allowable <sup>2</sup>	Deliveries <sup>3</sup>	Adjusted Right <sup>4</sup>	Maximum Allowable <sup>2</sup>	Deliveries <sup>3</sup>	Adjusted Right <sup>1</sup>	Maximum Allowable <sup>2</sup>	Deliveries <sup>3</sup>
1991	52,199	67,859	49,697	1,427	1,855	155	1,230	1,599	0	49,542	64,405	49,542
1992	52,199	67,859	43,062	1,427	1,855	203	1,230	1,599	0	49,542	64,405	42,859
1993	52,199	67,859	44,962	1,427	1,855	-108	1,230	1,599	0	49,542	64,405	42,305
1994	52,199	67,859	51,340	1,427	1,855	46	1,230	1,599	0	49,542	64,405	49,542
1995	52,199	67,859	49,593	1,427	1,855	99	1,230	1,599	0	49,542	64,405	46,936
1996	52,199	67,859	54,992	1,427	1,855	278	1,230	1,599	0	49,542	64,405	52,335
1997	52,199	67,859	52,443	1,427	1,855	494	1,230	1,599	0	49,542	64,405	49,786
1998	52,199	67,859	47,746	1,427	1,855	0	1,230	1,599	0	49,542	64,405	47,746
1999	52,199	67,859	52,199	1,427	1,855	181	1,230	1,599	0	49,542	64,405	49,542
2000	52,199	67,859	52,199	1,427	1,855	117	1,230	1,599	0	49,542	64,405	49,542
2001	52,199	67,859	52,199	1,427	1,855	229	1,230	1,599	0	49,542	64,405	49,542
2002	52,199	67,859	52,199	1,427	1,855	172	1,230	1,599	0	49,542	64,405	49,542
2003	52,199	67,859	54,514	1,427	1,855	10	1,230	1,599	0	49,542	64,405	54,504
2004	52,199	67,859	52,199	1,427	1,855	0	1,230	1,599	0	49,542	64,405	49,542
2005	52,199	67,859	44,696	1,427	1,855	13	1,230	1,599	0	49,542	64,405	44,683
2006	52,199	67,859	49,444	1,427	1,855	30	1,230	1,599	0	49,542	64,405	49,414
2007	52,199	67,859	49,559	1,427	1,855	39	1,230	1,599	0	49,542	64,405	49,520
2008	52,199	67,859	53,581	1,427	1,855	70	1,230	1,599	0	49,542	64,405	53,511
2009	52,199	67,859	43,061	1,427	1,855	121	1,230	1,599	0	49,542	64,405	42,940
2010	52,199	67,859	45,713	1,427	1,855	80	1,230	1,599	0	49,542	64,405	45,633

TABLE NO. 10  
 ANNUAL ACCOUNTING OF EXTRACTIONS BY THE CITY OF RIVERSIDE  
 FROM THE SAN BERNARDINO BASIN AREA  
 FOR DELIVERY TO EACH SERVICE AREA  
 (Including those rights acquired as successor to the  
 Riverside Water Company and the Gage Canal Company)  
 ANNUAL TOTALS  
 (All Values in Acre-Feet)

Calendar Year	Verified Extractions from the San Bernardino Basin Area			Delivery for Use in San Bernardino Basin Area			Delivery for Use in Colton Basin Area and Riverside Basin Area in San Bernardino County			Delivery for Use in Areas Outside San Bernardino Valley		
	Adjusted Right <sup>1</sup>	Maximum Allowable <sup>2</sup>	Extractions <sup>3</sup>	Adjusted Right <sup>4</sup>	Maximum Allowable <sup>2</sup>	Deliveries <sup>3</sup>	Adjusted Right <sup>4</sup>	Maximum Allowable <sup>2</sup>	Deliveries <sup>3</sup>	Adjusted Right <sup>1</sup>	Maximum Allowable <sup>2</sup>	Deliveries <sup>3</sup>
2011	52,199	67,859	46,488	1,427	1,855	72	1,230	1,599	0	49,542	64,405	46,416
2012	52,199	67,859	52,506	1,427	1,855	13	1,230	1,599	0	49,542	64,405	52,493
2013	53,918	70,093	52,617	1,427	1,855	11	1,230	1,599	0	51,261	66,639	52,606
2014	53,918	70,093		1,427	1,855		1,230	1,599		51,261	66,639	
2015	53,918	70,093		1,427	1,855		1,230	1,599		51,261	66,639	
2016	53,918	70,093		1,427	1,855		1,230	1,599		51,261	66,639	
2017	53,918	70,093		1,427	1,855		1,230	1,599		51,261	66,639	
2018	53,918	70,093		1,427	1,855		1,230	1,599		51,261	66,639	
2019	53,918	70,093		1,427	1,855		1,230	1,599		51,261	66,639	
2020	53,918	70,093		1,427	1,855		1,230	1,599		51,261	66,639	

See Report of Watermaster, Tables 3A-1 and 3A-2.

<sup>1</sup> Adjusted Right equals Safe Yield Adjusted Right plus New Conservation Allocation.

<sup>2</sup> Maximum Allowable for any one year, not to exceed 130% of Adjusted Right.

<sup>3</sup> Extractions and Deliveries from Table No. 3A-2.

<sup>4</sup> New Conservation Allocation may also be used in the San Bernardino Basin Area, or the Colton Basin Area and Riverside Basin Area in San Bernardino County.

Note: Annual Accounting of Extractions as required in Paragraphs V and VI of the Judgment.

TABLE NO. 10  
 ANNUAL ACCOUNTING OF EXTRactions BY THE CITY OF RIVERSIDE  
 FROM THE SAN BERNARDINO BASIN AREA  
 FOR DELIVERY TO EACH SERVICE AREA  
 (Including those rights acquired as successor to the  
 Riverside Water Company and the Gage Canal Company)  
 FIVE-YEAR TOTALS  
 (All Values in Acre-Feet)

Five-Year Period	Verified Extractions from the San Bernardino Basin Area			Delivery for Use in San Bernardino Basin Area			Delivery for Use in Colton Basin Area and Riverside Basin Area in San Bernardino County			Delivery for Use in Areas Outside San Bernardino Valley		
	Adjusted Right <sup>1</sup>	Maximum Allowable <sup>2</sup>	Extractions <sup>3</sup>	Adjusted Right <sup>4</sup>	Maximum Allowable <sup>2</sup>	Deliveries <sup>3</sup>	Adjusted Right <sup>4</sup>	Maximum Allowable <sup>2</sup>	Deliveries <sup>3</sup>	Adjusted Right <sup>1</sup>	Maximum Allowable <sup>2</sup>	Deliveries <sup>3</sup>
1971-75	262,244	262,244	233,927	7,170	7,170	339	6,180	6,180	2,776	248,894	248,894	230,812
1972-76	260,995	260,995	231,419	7,135	7,135	241	6,150	6,150	2,630	247,710	247,710	228,548
1973-77	260,995	260,995	236,724	7,135	7,135	156	6,150	6,150	2,429	247,710	247,710	234,139
1974-78	260,995	260,995	239,086	7,135	7,135	646	6,150	6,150	2,218	247,710	247,710	236,222
1975-79	260,995	260,995	248,096	7,135	7,135	646	6,150	6,150	2,083	247,710	247,710	245,367
1976-80	260,995	260,995	250,890	7,135	7,135	1,029	6,150	6,150	1,585	247,710	247,710	248,276
1977-81	260,995	260,995	250,525	7,135	7,135	1,753	6,150	6,150	1,062	247,710	247,710	247,710
1978-82	260,995	260,995	249,125	7,135	7,135	1,915	6,150	6,150	716	247,710	247,710	246,494
1979-83	260,995	260,995	249,729	7,135	7,135	1,604	6,150	6,150	415	247,710	247,710	247,710
1980-84	260,995	260,995	246,926	7,135	7,135	1,636	6,150	6,150	0	247,710	247,710	245,290
1981-85	260,995	260,995	245,771	7,135	7,135	1,312	6,150	6,150	0	247,710	247,710	244,459
1982-86	260,995	260,995	244,741	7,135	7,135	1,025	6,150	6,150	0	247,710	247,710	243,716
1983-87	260,995	260,995	245,018	7,135	7,135	1,197	6,150	6,150	0	247,710	247,710	243,821
1984-88	260,995	260,995	249,341	7,135	7,135	1,677	6,150	6,150	0	247,710	247,710	247,664
1985-89	260,995	260,995	250,551	7,135	7,135	1,673	6,150	6,150	0	247,710	247,710	248,878
1986-90	260,995	260,995	248,587	7,135	7,135	1,633	6,150	6,150	0	247,710	247,710	246,954
1987-91	260,995	260,995	248,305	7,135	7,135	1,351	6,150	6,150	0	247,710	247,710	246,954
1988-92	260,995	260,995	241,491	7,135	7,135	1,220	6,150	6,150	0	247,710	247,710	240,271
1989-93	260,995	260,995	236,142	7,135	7,135	297	6,150	6,150	0	247,710	247,710	233,080
1990-94	260,995	260,995	236,698	7,135	7,135	315	6,150	6,150	0	247,710	247,710	231,866

133

TABLE NO. 10  
 ANNUAL ACCOUNTING OF EXTRactions BY THE CITY OF RIVERSIDE  
 FROM THE SAN BERNARDINO BASIN AREA  
 FOR DELIVERY TO EACH SERVICE AREA  
 (Including those rights acquired as successor to the  
 Riverside Water Company and the Gage Canal Company)  
 FIVE-YEAR TOTALS  
 (All Values in Acre-Feet)

Five-Year Period	Verified Extractions from the San Bernardino Basin Area			Delivery for Use in San Bernardino Basin Area			Delivery for Use in Colton Basin Area and Riverside Basin Area in San Bernardino County			Delivery for Use in Areas Outside San Bernardino Valley		
	Adjusted Right <sup>1</sup>	Maximum Allowable <sup>2</sup>	Extractions <sup>3</sup>	Adjusted Right <sup>4</sup>	Maximum Allowable <sup>2</sup>	Deliveries <sup>3</sup>	Adjusted Right <sup>4</sup>	Maximum Allowable <sup>2</sup>	Deliveries <sup>3</sup>	Adjusted Right <sup>1</sup>	Maximum Allowable <sup>2</sup>	Deliveries <sup>3</sup>
1991-95	260,995	260,995	238,654	7,135	7,135	395	6,150	6,150	0	247,710	247,710	231,184
1992-96	260,995	260,995	243,949	7,135	7,135	518	6,150	6,150	0	247,710	247,710	233,977
1993-97	260,995	260,995	253,330	7,135	7,135	809	6,150	6,150	0	247,710	247,710	240,904
1994-98	260,995	260,995	256,114	7,135	7,135	917	6,150	6,150	0	247,710	247,710	246,345
1995-99	260,995	260,995	256,973	7,135	7,135	1,052	6,150	6,150	0	247,710	247,710	246,345
1996-00	260,995	260,995	259,579	7,135	7,135	1,070	6,150	6,150	0	247,710	247,710	248,951
1997-01	260,995	260,995	256,786	7,135	7,135	1,021	6,150	6,150	0	247,710	247,710	246,158
1998-02	260,995	260,995	256,542	7,135	7,135	699	6,150	6,150	0	247,710	247,710	245,914
1999-03	260,995	260,995	263,310	7,135	7,135	709	6,150	6,150	0	247,710	247,710	252,672
2000-04	260,995	260,995	263,310	7,135	7,135	528	6,150	6,150	0	247,710	247,710	252,672
2001-05	260,995	260,995	255,807	7,135	7,135	424	6,150	6,150	0	247,710	247,710	247,813
2002-06	260,995	260,995	253,052	7,135	7,135	225	6,150	6,150	0	247,710	247,710	247,685
2003-07	260,995	260,995	250,412	7,135	7,135	92	6,150	6,150	0	247,710	247,710	247,663
2004-08	260,995	260,995	249,479	7,135	7,135	152	6,150	6,150	0	247,710	247,710	246,670
2005-09	260,995	260,995	240,341	7,135	7,135	273	6,150	6,150	0	247,710	247,710	240,068
2006-10	260,995	260,995	241,358	7,135	7,135	340	6,150	6,150	0	247,710	247,710	241,018
2007-11	260,995	260,995	238,402	7,135	7,135	382	6,150	6,150	0	247,710	247,710	238,020
2008-12	260,995	260,995	241,349	7,135	7,135	356	6,150	6,150	0	247,710	247,710	240,993
2009-13	262,714	262,714	240,385	7,135	7,135	297	6,150	6,150	0	249,429	249,429	240,088
2010-14	264,433	264,433		7,135	7,135		6,150	6,150		251,148	251,148	

134

TABLE NO. 10  
 ANNUAL ACCOUNTING OF EXTRactions BY THE CITY OF RIVERSIDE  
 FROM THE SAN BERNARDINO BASIN AREA  
 FOR DELIVERY TO EACH SERVICE AREA  
 (Including those rights acquired as successor to the  
 Riverside Water Company and the Gage Canal Company)  
 FIVE-YEAR TOTALS  
 (All Values in Acre-Feet)

Five-Year Period	Verified Extractions from the San Bernardino Basin Area			Delivery for Use in San Bernardino Basin Area			Delivery for Use in Colton Basin Area and Riverside Basin Area in San Bernardino County			Delivery for Use in Areas Outside San Bernardino Valley		
	Adjusted Right <sup>1</sup>	Maximum Allowable <sup>2</sup>	Extractions <sup>3</sup>	Adjusted Right <sup>4</sup>	Maximum Allowable <sup>2</sup>	Deliveries <sup>3</sup>	Adjusted Right <sup>4</sup>	Maximum Allowable <sup>2</sup>	Deliveries <sup>3</sup>	Adjusted Right <sup>1</sup>	Maximum Allowable <sup>2</sup>	Deliveries <sup>3</sup>
2011-15	266,152	266,152		7,135	7,135		6,150	6,150		252,867	252,867	
2012-16	267,871	267,871		7,135	7,135		6,150	6,150		254,586	254,586	
2013-17	269,590	269,590		7,135	7,135		6,150	6,150		256,305	256,305	
2014-18	269,590	269,590		7,135	7,135		6,150	6,150		256,305	256,305	
2015-19	269,590	269,590		7,135	7,135		6,150	6,150		256,305	256,305	
2016-20	269,590	269,590		7,135	7,135		6,150	6,150		256,305	256,305	
Excess Extractions												
2009-13		(22,329) *			(6,838) *			(6,150) *			(9,341) *	

\* Parentheses indicate that Extractions and Deliveries are less than Adjusted Right.

1 Adjusted Right equals Safe Yield Adjusted Right plus New Conservation Allocation.

2 Maximum allowable for the five-year period is the same as the five-year-period Adjusted Right.

3 Extractions and Deliveries from Table No. 3A-2.

4 New Conservation Allocation may also be used in the San Bernardino Basin Area, or the Colton Basin Area and Riverside Basin Area in San Bernardino County.

135

TABLE NO. 10A  
 ALLOWABLE EXTRACTIONS BY THE CITY OF RIVERSIDE  
 FROM THE SAN BERNARDINO BASIN AREA  
 FOR DELIVERY TO EACH SERVICE AREA  
 (Including those rights acquired as successor to the  
 Riverside Water Company and the Gage Canal Company)

CALENDAR YEAR 2014  
 (All Values in Acre-Feet)

		<u>Allowable Total Extractions from the San Bernardino Basin Area</u>	<u>Allowable Delivery for Use in San Bernardino Basin Area</u>	<u>Allowable Delivery for Use in Colton Basin Area and Riverside Basin Area in San Bernardino County</u>	<u>Allowable Delivery for Use in Areas Outside San Bernardino Valley</u>
Allowable Extraction Based on Adjusted Right	1	57,454	1,855	1,599	54,000
Imported Water Available In Holding Account	2	2,459	See Footnote 5	See Footnote 5	2,459
New Conservation Water Available	3	<u>9,635</u>	<u>See Footnote 6</u>	<u>See Footnote 6</u>	<u>9,635</u>
Total Allowable Extraction	4	69,548	1,855	1,599	66,094



TABLE NO. 10A  
 ALLOWABLE EXTRACTIONS BY THE CITY OF RIVERSIDE  
 FROM THE SAN BERNARDINO BASIN AREA  
 FOR DELIVERY TO EACH SERVICE AREA  
 (Including those rights acquired as successor to the  
 Riverside Water Company and the Gage Canal Company)

CALENDAR YEAR 2014  
 (All Values in Acre-Feet)

- 1 *Component of Total Allowable Extractions available through the adjusted right which is equal to the 1959-63 base period extractions minus an adjustment for safe yield and plus an adjustment to include new conservation water forecast to result from long term operation of Seven Oaks Reservoir and diversion of increased amounts for recharge at the Santa Ana River Spreading Grounds. The Allowable Delivery amounts are the adjusted right for the five year period ending with the subject year minus the sum of the Deliveries (Table 10, Page 1 of 3) for the previous four years or the Maximum Allowable annual delivery (1.3 times average annual allowable delivery) whichever is the lessor. Allowable Total Extractions is the sum of the allowable deliveries.*
- 2 *Component of Total Allowable Extraction available if Western has previously transferred to the City of Riverside the right to extract imported water and the City of Riverside has under extracted water in an amount equal to or less than the sum of the rights to extract that were previously transferred. The amount available for extraction by the City of Riverside is accounted for in Table No. 17B-1, and is referred to as Imported Water Net Accumulated (Credit).*
- 3 *Component of Total Allowable Extraction available as a result of Western, San Bernardino Valley and the Riverside Court approving a Judgment Paragraph VI (b) 6 agreement providing an allocation of new conservation water determined by Watermaster to have resulted from operation of Seven Oaks Reservoir from 1998 through 2012 and any future Judgment Paragraph VI (b) 6 agreement allocating new conservation water determined by Watermaster to have resulted from a future hydrologic event that resulted in direct use of Seven Oaks water or recharge of the San Bernardino Basin Area with Seven Oaks water in areas other than the Santa Ana River Spreading Grounds provided the capability to recharge at the Spreading Grounds has been fully utilized. The amount available for extraction by Riverside is accounted for in Table No. 17B-1, and is referred to as New Conservation Net Accumulated (Credit).*
- 4 *The Total Allowable Extraction is the sum of the allowable components described in Footnotes 1, 2 and 3.*
- 5 *Watermaster anticipates that the City of Riverside will not have excess extractions for delivery in the San Bernardino Basin Area or in the Colton and Riverside Basin Areas in San Bernardino County and therefore it is unlikely that Western will transfer a right to extract imported water for delivery in these areas. Therefore, it is unlikely that imported water resulting from under extractions will become available to the City of Riverside for delivery in these areas. However, if transfers of imported water and under extractions do occur, Watermaster will account for such occurrences at that time.*
- 6 *Watermaster anticipates that the City of Riverside will not have excess extractions for delivery in the San Bernardino Basin Area or in the Colton and Riverside Basin Areas in San Bernardino County and therefore the City of Riverside is unlikely to choose to use its allocation of new conservation water for deliveries in these areas. However, if excess extractions occur in these areas, the City of Riverside will likely choose to use its new conservation allocation to address the excess extraction and Watermaster will account for such use at that time.*

TABLE NO. 11  
 ANNUAL ACCOUNTING OF EXTRACTIONS BY RIVERSIDE HIGHLAND WATER COMPANY  
 FROM THE SAN BERNARDINO BASIN AREA  
 FOR DELIVERY TO EACH SERVICE AREA  
 ANNUAL TOTALS

(All Values in Acre-Feet)

Calendar Year	Verified Extractions from the San Bernardino Basin Area			Delivery for Use in San Bernardino Basin Area			Delivery for Use in Colton Basin Area and Riverside Basin Area in San Bernardino County			Delivery for Use in Areas Outside San Bernardino Valley		
	Adjusted Right <sup>1</sup>	Maximum Allowable <sup>2</sup>	Extractions <sup>3</sup>	Adjusted Right <sup>4</sup>	Maximum Allowable <sup>2</sup>	Deliveries <sup>3</sup>	Adjusted Right <sup>4</sup>	Maximum Allowable <sup>2</sup>	Deliveries <sup>3</sup>	Adjusted Right <sup>1</sup>	Maximum Allowable <sup>2</sup>	Deliveries <sup>3</sup>
1971	4,399	5,719	4,012	0	0	0	2,509	3,262	2,388	1,890	2,457	1,624
1972	4,294	5,582	4,532	0	0	0	2,449	3,184	2,239	1,845	2,399	2,293
1973	4,294	5,582	3,512	0	0	0	2,449	3,184	1,751	1,845	2,399	1,761
1974	4,294	5,582	4,088	0	0	0	2,449	3,184	1,985	1,845	2,399	2,103
1975	4,294	5,582	4,709	0	0	0	2,449	3,184	2,002	1,845	2,399	2,707
1976	4,294	5,582	4,519	0	0	0	2,449	3,184	2,050	1,845	2,399	2,469
1977	4,294	5,582	3,583	0	0	0	2,449	3,184	1,820	1,845	2,399	1,763
1978	4,294	5,582	1,350	0	0	0	2,449	3,184	1,051	1,845	2,399	299
1979	4,294	5,582	3,369	0	0	0	2,449	3,184	1,781	1,845	2,399	1,588
1980	4,294	5,582	3,677	0	0	0	2,449	3,184	2,060	1,845	2,399	1,617
1981	4,294	5,582	3,604	0	0	0	2,449	3,184	2,151	1,845	2,399	1,453
1982	4,294	5,582	2,795	0	0	0	2,449	3,184	1,775	1,845	2,399	1,020
1983	4,294	5,582	3,161	0	0	0	2,449	3,184	2,318	1,845	2,399	843
1984	4,294	5,582	4,759	0	0	0	2,449	3,184	2,671	1,845	2,399	2,088
1985	4,294	5,582	3,312	0	0	0	2,449	3,184	1,978	1,845	2,399	1,334
1986	4,294	5,582	4,744	0	0	0	2,449	3,184	2,130	1,845	2,399	2,614
1987	4,294	5,582	3,919	0	0	0	2,449	3,184	2,229	1,845	2,399	1,690
1988	4,294	5,582	4,775	0	0	0	2,449	3,184	2,229	1,845	2,399	2,546
1989	4,294	5,582	4,681	0	0	0	2,449	3,184	1,968	1,845	2,399	2,713
1990	4,294	5,582	4,092	0	0	0	2,449	3,184	2,313	1,845	2,399	1,779

138

TABLE NO. 11  
 ANNUAL ACCOUNTING OF EXTRACTIONS BY RIVERSIDE HIGHLAND WATER COMPANY  
 FROM THE SAN BERNARDINO BASIN AREA  
 FOR DELIVERY TO EACH SERVICE AREA  
 ANNUAL TOTALS

(All Values in Acre-Feet)

Calendar Year	Verified Extractions from the San Bernardino Basin Area			Delivery for Use in San Bernardino Basin Area			Delivery for Use in Colton Basin Area and Riverside Basin Area in San Bernardino County			Delivery for Use in Areas Outside San Bernardino Valley		
	Adjusted Right <sup>1</sup>	Maximum Allowable <sup>2</sup>	Extractions <sup>3</sup>	Adjusted Right <sup>4</sup>	Maximum Allowable <sup>2</sup>	Deliveries <sup>3</sup>	Adjusted Right <sup>4</sup>	Maximum Allowable <sup>2</sup>	Deliveries <sup>3</sup>	Adjusted Right <sup>1</sup>	Maximum Allowable <sup>2</sup>	Deliveries <sup>3</sup>
1991	4,294	5,582	3,021	0	0	0	2,449	3,184	1,669	1,845	2,399	1,352
1992	4,294	5,582	4,052	0	0	0	2,449	3,184	2,275	1,845	2,399	1,777
1993	4,294	5,582	3,241	0	0	0	2,449	3,184	1,777	1,845	2,399	1,464
1994	4,294	5,582	4,324	0	0	0	2,449	3,184	2,201	1,845	2,399	2,123
1995	4,294	5,582	3,955	0	0	0	2,449	3,184	2,146	1,845	2,399	1,809
1996	4,294	5,582	4,588	0	0	0	2,449	3,184	2,756	1,845	2,399	1,832
1997	4,294	5,582	4,476	0	0	0	2,449	3,184	2,656	1,845	2,399	1,820
1998	4,294	5,582	2,787	0	0	0	2,449	3,184	1,961	1,845	2,399	826
1999	4,294	5,582	2,931	0	0	0	2,449	3,184	2,082	1,845	2,399	849
2000	4,294	5,582	2,856	0	0	0	2,449	3,184	2,811	1,845	2,399	45
2001	4,294	5,582	2,665	0	0	0	2,449	3,184	2,543	1,845	2,399	122
2002	4,294	5,582	2,400	0	0	0	2,449	3,184	2,272	1,845	2,399	128
2003	4,294	5,582	3,878	0	0	0	2,449	3,184	2,036	1,845	2,399	1,842
2004	4,294	5,582	1,754	0	0	0	2,449	3,184	1,301	1,845	2,399	453
2005	4,294	5,582	3,377	0	0	0	2,449	3,184	1,532	1,845	2,399	1,845
2006	4,294	5,582	4,149	0	0	0	2,449	3,184	2,304	1,845	2,399	1,845
2007	4,294	5,582	3,633	0	0	0	2,449	3,184	1,772	1,845	2,399	1,861
2008	4,294	5,582	2,730	0	0	0	2,449	3,184	2,054	1,845	2,399	676
2009	4,294	5,582	1,648	0	0	0	2,449	3,184	1,073	1,845	2,399	575
2010	4,294	5,582	1,136	0	0	0	2,449	3,184	629	1,845	2,399	507

139

TABLE NO. 11  
 ANNUAL ACCOUNTING OF EXTRACTIONS BY RIVERSIDE HIGHLAND WATER COMPANY  
 FROM THE SAN BERNARDINO BASIN AREA  
 FOR DELIVERY TO EACH SERVICE AREA  
 ANNUAL TOTALS

(All Values in Acre-Feet)

Calendar Year	Verified Extractions from the San Bernardino Basin Area			Delivery for Use in San Bernardino Basin Area			Delivery for Use in Colton Basin Area and Riverside Basin Area in San Bernardino County			Delivery for Use in Areas Outside San Bernardino Valley		
	Adjusted Right <sup>1</sup>	Maximum Allowable <sup>2</sup>	Extractions <sup>3</sup>	Adjusted Right <sup>4</sup>	Maximum Allowable <sup>2</sup>	Deliveries <sup>3</sup>	Adjusted Right <sup>4</sup>	Maximum Allowable <sup>2</sup>	Deliveries <sup>3</sup>	Adjusted Right <sup>1</sup>	Maximum Allowable <sup>2</sup>	Deliveries <sup>3</sup>
2011	4,294	5,582	1,655	0	0	0	2,449	3,184	1,087	1,845	2,399	568
2012	4,294	5,582	2,135	0	0	0	2,449	3,184	1,523	1,845	2,399	612
2013	4,435	5,766	2,873	0	0	0	2,449	3,184	1,629	1,986	2,582	1,244
2014	4,435	5,766		0	0		2,449	3,184		1,986	2,582	
2015	4,435	5,766		0	0		2,449	3,184		1,986	2,582	
2016	4,435	5,766		0	0		2,449	3,184		1,986	2,582	
2017	4,435	5,766		0	0		2,449	3,184		1,986	2,582	
2018	4,435	5,766		0	0		2,449	3,184		1,986	2,582	
2019	4,435	5,766		0	0		2,449	3,184		1,986	2,582	
2020	4,435	5,766		0	0		2,449	3,184		1,986	2,582	

See Report of Watermaster, Tables 3B-1 and 3B-2.

<sup>1</sup> Adjusted Right equals Safe Yield Adjusted Right plus New Conservation Allocation.

<sup>2</sup> Maximum Allowable for any one year, not to exceed 130% of Adjusted Right.

<sup>3</sup> Extractions and Deliveries from Table No. 3B-2. (Volume 1A, Table 3)

<sup>4</sup> New Conservation Allocation may also be used in the San Bernardino Basin Area, or the Colton Basin Area and Riverside Basin Area in San Bernardino County.

Note: Annual Accounting of Extractions as required in Paragraphs V and VI of the Judgment.

140

TABLE NO. 11  
 ANNUAL ACCOUNTING OF EXTRACTIONS BY RIVERSIDE HIGHLAND WATER COMPANY  
 FROM THE SAN BERNARDINO BASIN AREA  
 FOR DELIVERY TO EACH SERVICE AREA  
 FIVE-YEAR TOTALS

(All Values in Acre-Feet)

Five-Year Period	Verified Extractions from the San Bernardino Basin Area			Delivery for Use in San Bernardino Basin Area			Delivery for Use in Colton Basin Area and Riverside Basin Area in San Bernardino County			Delivery for Use in Areas Outside San Bernardino Valley		
	Adjusted Right <sup>1</sup>	Maximum Allowable <sup>2</sup>	Extractions <sup>3</sup>	Adjusted Right <sup>4</sup>	Maximum Allowable <sup>2</sup>	Deliveries <sup>3</sup>	Adjusted Right <sup>4</sup>	Maximum Allowable <sup>2</sup>	Deliveries <sup>3</sup>	Adjusted Right <sup>1</sup>	Maximum Allowable <sup>2</sup>	Deliveries <sup>3</sup>
1971-75	21,575	21,575	20,853	0	0	0	12,305	12,305	10,365	9,270	9,270	10,488
1972-76	21,470	21,470	21,360	0	0	0	12,245	12,245	10,027	9,225	9,225	11,333
1973-77	21,470	21,470	20,411	0	0	0	12,245	12,245	9,608	9,225	9,225	10,803
1974-78	21,470	21,470	18,249	0	0	0	12,245	12,245	8,908	9,225	9,225	9,341
1975-79	21,470	21,470	17,530	0	0	0	12,245	12,245	8,704	9,225	9,225	8,826
1976-80	21,470	21,470	16,498	0	0	0	12,245	12,245	8,762	9,225	9,225	7,736
1977-81	21,470	21,470	15,583	0	0	0	12,245	12,245	8,863	9,225	9,225	6,720
1978-82	21,470	21,470	14,795	0	0	0	12,245	12,245	8,818	9,225	9,225	5,977
1979-83	21,470	21,470	16,606	0	0	0	12,245	12,245	10,085	9,225	9,225	6,521
1980-84	21,470	21,470	17,996	0	0	0	12,245	12,245	10,975	9,225	9,225	7,021
1981-85	21,470	21,470	17,631	0	0	0	12,245	12,245	10,893	9,225	9,225	6,738
1982-86	21,470	21,470	18,771	0	0	0	12,245	12,245	10,872	9,225	9,225	7,899
1983-87	21,470	21,470	19,895	0	0	0	12,245	12,245	11,326	9,225	9,225	8,569
1984-88	21,470	21,470	21,509	0	0	0	12,245	12,245	11,237	9,225	9,225	10,272
1985-89	21,470	21,470	21,431	0	0	0	12,245	12,245	10,534	9,225	9,225	10,897
1986-90	21,470	21,470	22,211	0	0	0	12,245	12,245	10,869	9,225	9,225	11,342
1987-91	21,470	21,470	20,488	0	0	0	12,245	12,245	10,408	9,225	9,225	10,080
1988-92	21,470	21,470	20,621	0	0	0	12,245	12,245	10,454	9,225	9,225	10,167
1989-93	21,470	21,470	19,087	0	0	0	12,245	12,245	10,002	9,225	9,225	9,085
1990-94	21,470	21,470	18,730	0	0	0	12,245	12,245	10,235	9,225	9,225	8,495

141

TABLE NO. 11  
 ANNUAL ACCOUNTING OF EXTRACTIONS BY RIVERSIDE HIGHLAND WATER COMPANY  
 FROM THE SAN BERNARDINO BASIN AREA  
 FOR DELIVERY TO EACH SERVICE AREA  
 FIVE-YEAR TOTALS

(All Values in Acre-Feet)

Five-Year Period	Verified Extractions from the San Bernardino Basin Area			Delivery for Use in San Bernardino Basin Area			Delivery for Use in Colton Basin Area and Riverside Basin Area in San Bernardino County			Delivery for Use in Areas Outside San Bernardino Valley		
	Adjusted Right <sup>1</sup>	Maximum Allowable <sup>2</sup>	Extractions <sup>3</sup>	Adjusted Right <sup>4</sup>	Maximum Allowable <sup>2</sup>	Deliveries <sup>3</sup>	Adjusted Right <sup>4</sup>	Maximum Allowable <sup>2</sup>	Deliveries <sup>3</sup>	Adjusted Right <sup>1</sup>	Maximum Allowable <sup>2</sup>	Deliveries <sup>3</sup>
	1991-95	21,470	21,470	18,593	0	0	0	12,245	12,245	10,068	9,225	9,225
1992-96	21,470	21,470	20,160	0	0	0	12,245	12,245	11,155	9,225	9,225	9,005
1993-97	21,470	21,470	20,584	0	0	0	12,245	12,245	11,536	9,225	9,225	9,048
1994-98	21,470	21,470	20,130	0	0	0	12,245	12,245	11,720	9,225	9,225	8,410
1995-99	21,470	21,470	18,737	0	0	0	12,245	12,245	11,601	9,225	9,225	7,136
1996-00	21,470	21,470	17,638	0	0	0	12,245	12,245	12,266	9,225	9,225	5,372
1997-01	21,470	21,470	15,715	0	0	0	12,245	12,245	12,053	9,225	9,225	3,662
1998-02	21,470	21,470	13,639	0	0	0	12,245	12,245	11,669	9,225	9,225	1,970
1999-03	21,470	21,470	14,730	0	0	0	12,245	12,245	11,744	9,225	9,225	2,986
2000-04	21,470	21,470	13,553	0	0	0	12,245	12,245	10,963	9,225	9,225	2,590
2001-05	21,470	21,470	14,074	0	0	0	12,245	12,245	9,684	9,225	9,225	4,390
2002-06	21,470	21,470	15,558	0	0	0	12,245	12,245	9,445	9,225	9,225	6,113
2003-07	21,470	21,470	16,791	0	0	0	12,245	12,245	8,945	9,225	9,225	7,846
2004-08	21,470	21,470	15,643	0	0	0	12,245	12,245	8,963	9,225	9,225	6,680
2005-09	21,470	21,470	15,537	0	0	0	12,245	12,245	8,735	9,225	9,225	6,802
2006-10	21,470	21,470	13,296	0	0	0	12,245	12,245	7,832	9,225	9,225	5,464
2007-11	21,470	21,470	10,802	0	0	0	12,245	12,245	6,615	9,225	9,225	4,187
2008-12	21,470	21,470	9,304	0	0	0	12,245	12,245	6,366	9,225	9,225	2,938
2009-13	21,611	21,611	9,447	0	0	0	12,245	12,245	5,941	9,366	9,366	3,506
2010-14	21,752	21,752		0	0		12,245	12,245		9,507	9,507	

142

TABLE NO. 11  
ANNUAL ACCOUNTING OF EXTRACTIONS BY RIVERSIDE HIGHLAND WATER COMPANY  
FROM THE SAN BERNARDINO BASIN AREA  
FOR DELIVERY TO EACH SERVICE AREA  
FIVE-YEAR TOTALS

(All Values in Acre-Feet)

Five-Year Period	Verified Extractions from the San Bernardino Basin Area			Delivery for Use in San Bernardino Basin Area			Delivery for Use in Colton Basin Area and Riverside Basin Area in San Bernardino County			Delivery for Use in Areas Outside San Bernardino Valley		
	Adjusted Right <sup>1</sup>	Maximum Allowable <sup>2</sup>	Extractions <sup>3</sup>	Adjusted Right <sup>4</sup>	Maximum Allowable <sup>2</sup>	Deliveries <sup>3</sup>	Adjusted Right <sup>4</sup>	Maximum Allowable <sup>2</sup>	Deliveries <sup>3</sup>	Adjusted Right <sup>1</sup>	Maximum Allowable <sup>2</sup>	Deliveries <sup>3</sup>
2011-15	21,893	21,893		0	0		12,245	12,245		9,648	9,648	
2012-16	22,034	22,034		0	0		12,245	12,245		9,789	9,789	
2013-17	22,175	22,175		0	0		12,245	12,245		9,930	9,930	
2014-17	22,175	22,175		0	0		12,245	12,245		9,930	9,930	
2015-19	22,175	22,175		0	0		12,245	12,245		9,930	9,930	
2016-20	22,175	22,175		0	0		12,245	12,245		9,930	9,930	
Excess Extractions 2009-13		(12,164) *			0 *			(6,304) *			(5,860) *	

\* Parentheses indicate that Extractions and Deliveries are less than Adjusted Right.

<sup>1</sup> Adjusted Right equals Safe Yield Adjusted Right plus New Conservation Allocation.

<sup>2</sup> Maximum allowable for the five-year period is the same as the five-year-period Adjusted Right.

<sup>3</sup> Extractions and Deliveries from Table No. 3B-2.

<sup>4</sup> New Conservation Allocation may also be used in the San Bernardino Basin Area, or the Colton Basin Area and Riverside Basin Area in San Bernardino County.

143

TABLE NO. 11A  
 ALLOWABLE EXTRACTIONS BY RIVERSIDE HIGHLAND WATER COMPANY  
 FROM THE SAN BERNARDINO BASIN AREA  
 FOR DELIVERY TO EACH SERVICE AREA

CALENDAR YEAR 2014  
 (All Values in Acre-Feet)

		<u>Allowable Total Extractions from the San Bernardino Basin Area</u>	<u>Allowable Delivery for Use in San Bernardino Basin Area</u>	<u>Allowable Delivery for Use in Colton Basin Area and Riverside Basin Area in San Bernardino County</u>	<u>Allowable Delivery for Use in Areas Outside San Bernardino Valley</u>
Allowable Extraction Based on Adjusted Right	1	5,766	0	3,184	2,582
Imported Water Available In Holding Account	2	0	See Footnote 5	See Footnote 5	0 5
New Conservation Water Available	3	<u>793</u>	<u>See Footnote 6</u>	<u>See Footnote 6</u>	<u>793 6</u>
Total Allowable Extraction	4	6,559	0	3,184	3,375



TABLE NO. 11A  
 ALLOWABLE EXTRACTIONS BY RIVERSIDE HIGHLAND WATER COMPANY  
 FROM THE SAN BERNARDINO BASIN AREA  
 FOR DELIVERY TO EACH SERVICE AREA

CALENDAR YEAR 2014  
 (All Values in Acre-Feet)

- 1 *Component of Total Allowable Extractions available through the adjusted right which is equal to the 1959-63 base period extractions minus an adjustment for safe yield and plus an adjustment to include new conservation water forecast to result from long term operation of Seven Oaks Reservoir and diversion of increased amounts for recharge at the Santa Ana River Spreading Grounds. The Allowable Delivery amounts are the adjusted right for the five year period ending with the subject year minus the sum of the Deliveries (Table 11, Page 1 of 3) for the previous four years or the Maximum Allowable annual delivery (1.3 times average annual allowable delivery) whichever is the lessor. Allowable Total Extractions is the sum of the allowable deliveries.*
- 2 *Component of Total Allowable Extraction available if Western has previously transferred to Riverside Highland Water Company the right to extract imported water and Riverside Highland Water Company has under extracted water in an amount equal to or less than the sum of the rights to extract that were previously transferred. The amount available for extraction by Riverside Highland Water Company is accounted for in Table No. 17B-2, and is referred to as Imported Water Net Accumulated (Credit).*
- 3 *Component of Total Allowable Extraction available as a result of Western, San Bernardino Valley and the Riverside Court approving a Judgment Paragraph VI (b) 6 agreement providing an allocation of new conservation water determined by Watermaster to have resulted from operation of Seven Oaks Reservoir from 1998 through 2012 and any future Judgment Paragraph VI (b) 6 agreement allocating new conservation water determined by Watermaster to have resulted from a future hydrologic event that resulted in direct use of Seven Oaks water or recharge of the San Bernardino Basin Area with Seven Oaks water in areas other than the Santa Ana River Spreading Grounds provided the capability to recharge at the Spreading Grounds has been fully utilized. The amount available for extraction by Riverside Highland Water Company is accounted for in Table No. 17B-2, and is referred to as New Conservation Net Accumulated (Credit).*
- 4 *The Total Allowable Extraction is the sum of the allowable components described in Footnotes 1, 2 and 3.*
- 5 *Watermaster recognizes that Riverside Highland Water Company may have excess extractions for delivery in either the Colton Basin Area in San Bernardino County or for use in areas outside San Bernardino Valley and therefore Western may transfer a right to extract imported water for delivery in either of these areas. Therefore, it is possible that imported water resulting from under extractions may become available to Riverside Highland Water Company for delivery in either of these areas. If transfers of imported water and under extractions occur, Watermaster will account for such occurrences at that time.*
- 6 *Watermaster recognizes that Riverside Highland Water Company may have excess extractions for delivery in either the Colton Basin Area in San Bernardino County or for use in areas outside San Bernardino Valley and therefore Riverside Highland Water Company may choose to use its allocation of new conservation water for deliveries in either of these areas. If excess extractions occur in either of these areas and Riverside Highland Water Company chooses to use its new conservation allocation to address the excess extraction, Watermaster will account for such use in either area as requested by Riverside Highland Water Company at that time.*

TABLE NO. 12  
 ANNUAL ACCOUNTING OF EXTRactions BY AGUA MANSA WATER COMPANY AND MEEKS & DALEY WATER COMPANY  
 FROM THE SAN BERNARDINO BASIN AREA  
 FOR DELIVERY TO EACH SERVICE AREA  
 ANNUAL TOTALS

(All Values in Acre-Feet)

Calendar Year	Verified Extractions from the San Bernardino Basin Area			Delivery for Use in San Bernardino Basin Area			Delivery for Use in Colton Basin Area and Riverside Basin Area in San Bernardino County			Delivery for Use in Areas Outside San Bernardino Valley		
	Adjusted Right <sup>1</sup>	Maximum Allowable <sup>2</sup>	Extractions <sup>3</sup>	Adjusted Right <sup>4</sup>	Maximum Allowable <sup>2</sup>	Deliveries <sup>3</sup>	Adjusted Right <sup>4</sup>	Maximum Allowable <sup>2</sup>	Deliveries <sup>3</sup>	Adjusted Right <sup>1</sup>	Maximum Allowable <sup>2</sup>	Deliveries <sup>3</sup>
1971	8,026	10,434	2,902	0	0	0	325	423	383	7,700	10,010	2,519
1972	7,833	10,183	3,527	0	0	0	318	413	377	7,515	9,770	3,150
1973	7,833	10,183	2,979	0	0	0	318	413	250	7,515	9,770	2,729
1974	7,833	10,183	4,504	0	0	0	318	413	246	7,515	9,770	4,258
1975	7,833	10,183	3,950	0	0	0	318	413	168	7,515	9,770	3,782
1976	7,833	10,183	5,393	0	0	0	318	413	182	7,515	9,770	5,211
1977	7,833	10,183	4,220	0	0	0	318	413	146	7,515	9,770	4,074
1978	7,833	10,183	2,254	0	0	0	318	413	161	7,515	9,770	2,093
1979	7,833	10,183	3,930	0	0	0	318	413	166	7,515	9,770	3,764
1980	7,833	10,183	2,333	0	0	0	318	413	323	7,515	9,770	2,010
1981	7,833	10,183	3,092	0	0	0	318	413	358	7,515	9,770	2,734
1982	7,833	10,183	3,716	0	0	0	318	413	169	7,515	9,770	3,547
1983	7,833	10,183	2,651	0	0	0	318	413	245	7,515	9,770	2,406
1984	7,833	10,183	5,165	0	0	0	318	413	233	7,515	9,770	4,932
1985	7,833	10,183	5,385	0	0	0	318	413	210	7,515	9,770	5,175
1986	7,833	10,183	5,570	0	0	0	318	413	234	7,515	9,770	5,336
1987	7,833	10,183	4,914	0	0	0	318	413	193	7,515	9,770	4,721
1988	7,833	10,183	4,966	0	0	0	318	413	233	7,515	9,770	4,733
1989	7,833	10,183	5,392	0	0	0	318	413	240	7,515	9,770	5,152
1990	7,833	10,183	3,851	0	0	0	318	413	83	7,515	9,770	3,768

146

TABLE NO. 12  
 ANNUAL ACCOUNTING OF EXTRactions BY AGUA MANSA WATER COMPANY AND MEEKS & DALEY WATER COMPANY  
 FROM THE SAN BERNARDINO BASIN AREA  
 FOR DELIVERY TO EACH SERVICE AREA  
 ANNUAL TOTALS

(All Values in Acre-Feet)

Calendar Year	Verified Extractions from the San Bernardino Basin Area			Delivery for Use in San Bernardino Basin Area			Delivery for Use in Colton Basin Area and Riverside Basin Area in San Bernardino County			Delivery for Use in Areas Outside San Bernardino Valley		
	Adjusted Right <sup>1</sup>	Maximum Allowable <sup>2</sup>	Extractions <sup>3</sup>	Adjusted Right <sup>4</sup>	Maximum Allowable <sup>2</sup>	Deliveries <sup>3</sup>	Adjusted Right <sup>4</sup>	Maximum Allowable <sup>2</sup>	Deliveries <sup>3</sup>	Adjusted Right <sup>1</sup>	Maximum Allowable <sup>2</sup>	Deliveries <sup>3</sup>
1991	7,833	10,183	4,426	0	0	0	318	413	190	7,515	9,770	4,236
1992	7,833	10,183	4,100	0	0	0	318	413	118	7,515	9,770	3,982
1993	7,833	10,183	5,013	0	0	0	318	413	276	7,515	9,770	4,737
1994	7,833	10,183	4,525	0	0	0	318	413	227	7,515	9,770	4,298
1995	7,833	10,183	3,560	0	0	0	318	413	145	7,515	9,770	3,415
1996	7,833	10,183	3,912	0	0	0	318	413	194	7,515	9,770	3,718
1997	7,833	10,183	4,165	0	0	0	318	413	137	7,515	9,770	4,028
1998	7,833	10,183	3,828	0	0	0	318	413	210	7,515	9,770	3,618
1999	7,833	10,183	6,289	0	0	0	318	413	90	7,515	9,770	6,199
2000	7,833	10,183	3,832	0	0	0	318	413	352	7,515	9,770	3,480
2001	7,833	10,183	3,671	0	0	0	318	413	192	7,515	9,770	3,479
2002	7,833	10,183	5,800	0	0	0	318	413	202	7,515	9,770	5,598
2003	7,833	10,183	7,440	0	0	0	318	413	49	7,515	9,770	7,391
2004	7,833	10,183	3,782	0	0	0	318	413	19	7,515	9,770	3,763
2005	7,833	10,183	5,891	0	0	0	318	413	4	7,515	9,770	5,887
2006	7,833	10,183	7,515	0	0	0	318	413	0	7,515	9,770	7,515
2007	7,833	10,183	7,591	0	0	0	318	413	0	7,515	9,770	7,591
2008	7,833	10,183	4,832	0	0	0	318	413	0	7,515	9,770	4,832
2009	7,833	10,183	6,345	0	0	0	318	413	0	7,515	9,770	6,345
2010	7,833	10,183	6,738	0	0	0	318	413	0	7,515	9,770	6,738

147

TABLE NO. 12  
 ANNUAL ACCOUNTING OF EXTRactions BY AGUA MANSA WATER COMPANY AND MEEKS & DALEY WATER COMPANY  
 FROM THE SAN BERNARDINO BASIN AREA  
 FOR DELIVERY TO EACH SERVICE AREA  
 ANNUAL TOTALS

(All Values in Acre-Feet)

Calendar Year	Verified Extractions from the San Bernardino Basin Area			Delivery for Use in San Bernardino Basin Area			Delivery for Use in Colton Basin Area and Riverside Basin Area in San Bernardino County			Delivery for Use in Areas Outside San Bernardino Valley		
	Adjusted Right <sup>1</sup>	Maximum Allowable <sup>2</sup>	Extractions <sup>3</sup>	Adjusted Right <sup>4</sup>	Maximum Allowable <sup>2</sup>	Deliveries <sup>3</sup>	Adjusted Right <sup>4</sup>	Maximum Allowable <sup>2</sup>	Deliveries <sup>3</sup>	Adjusted Right <sup>1</sup>	Maximum Allowable <sup>2</sup>	Deliveries <sup>3</sup>
2011	7,833	10,183	7,127	0	0	0	318	413	0	7,515	9,770	7,127
2012	7,833	10,183	7,117	0	0	0	318	413	0	7,515	9,770	7,117
2013	8,091	10,518	7,732	0	0	0	318	413	0	7,773	10,105	7,732
2014	8,091	10,518		0	0		318	413		7,773	10,105	
2015	8,091	10,518		0	0		318	413		7,773	10,105	
2016	8,091	10,518		0	0		318	413		7,773	10,105	
2017	8,091	10,518		0	0		318	413		7,773	10,105	
2018	8,091	10,518		0	0		318	413		7,773	10,105	
2019	8,091	10,518		0	0		318	413		7,773	10,105	
2020	8,091	10,518		0	0		318	413		7,773	10,105	

See Report of Watermaster, Tables 3C-1 and 3C-2.

<sup>1</sup> Adjusted Right equals Safe Yield Adjusted Right plus New Conservation Allocation.

<sup>2</sup> Maximum Allowable for any one year, not to exceed 130% of Adjusted Right.

<sup>3</sup> Extractions and Deliveries from Table No. 3C-2. (Volume 1A, Table 3)

<sup>4</sup> New Conservation Allocation may also be used in the San Bernardino Basin Area, or the Colton Basin Area and Riverside Basin Area in San Bernardino County.

Note: Annual Accounting of Extractions as required in Paragraphs V and VI of the Judgment.

148

TABLE NO. 12  
 ANNUAL ACCOUNTING OF EXTRactions BY AGUA MANSA WATER COMPANY AND MEEKS & DALEY WATER COMPANY  
 FROM THE SAN BERNARDINO BASIN AREA  
 FOR DELIVERY TO EACH SERVICE AREA  
 FIVE-YEAR TOTALS

(All Values in Acre-Feet)

Five-Year Period	Verified Extractions from the San Bernardino Basin Area			Delivery for Use in San Bernardino Basin Area			Delivery for Use in Colton Basin Area and Riverside Basin Area in San Bernardino County			Delivery for Use in Areas Outside San Bernardino Valley		
	Adjusted Right <sup>1</sup>	Maximum Allowable <sup>2</sup>	Extractions <sup>3</sup>	Adjusted Right <sup>4</sup>	Maximum Allowable <sup>2</sup>	Deliveries <sup>3</sup>	Adjusted Right <sup>4</sup>	Maximum Allowable <sup>2</sup>	Deliveries <sup>3</sup>	Adjusted Right <sup>1</sup>	Maximum Allowable <sup>2</sup>	Deliveries <sup>3</sup>
1971-75	39,358	39,358	17,862	0	0	0	1,597	1,597	1,424	37,760	37,760	16,438
1972-76	39,165	39,165	20,353	0	0	0	1,590	1,590	1,223	37,575	37,575	19,130
1973-77	39,165	39,165	21,046	0	0	0	1,590	1,590	992	37,575	37,575	20,054
1974-78	39,165	39,165	20,321	0	0	0	1,590	1,590	903	37,575	37,575	19,418
1975-79	39,165	39,165	19,747	0	0	0	1,590	1,590	823	37,575	37,575	18,924
1976-80	39,165	39,165	18,130	0	0	0	1,590	1,590	978	37,575	37,575	17,152
1977-81	39,165	39,165	15,829	0	0	0	1,590	1,590	1,154	37,575	37,575	14,675
1978-82	39,165	39,165	15,325	0	0	0	1,590	1,590	1,177	37,575	37,575	14,148
1979-83	39,165	39,165	15,722	0	0	0	1,590	1,590	1,261	37,575	37,575	14,461
1980-84	39,165	39,165	16,957	0	0	0	1,590	1,590	1,328	37,575	37,575	15,629
1981-85	39,165	39,165	20,009	0	0	0	1,590	1,590	1,215	37,575	37,575	18,794
1982-86	39,165	39,165	22,487	0	0	0	1,590	1,590	1,091	37,575	37,575	21,396
1983-87	39,165	39,165	23,685	0	0	0	1,590	1,590	1,115	37,575	37,575	22,570
1984-88	39,165	39,165	26,000	0	0	0	1,590	1,590	1,103	37,575	37,575	24,897
1985-89	39,165	39,165	26,227	0	0	0	1,590	1,590	1,110	37,575	37,575	25,117
1986-90	39,165	39,165	24,693	0	0	0	1,590	1,590	983	37,575	37,575	23,710
1987-91	39,165	39,165	23,549	0	0	0	1,590	1,590	939	37,575	37,575	22,610
1988-92	39,165	39,165	22,735	0	0	0	1,590	1,590	864	37,575	37,575	21,871
1989-93	39,165	39,165	22,782	0	0	0	1,590	1,590	907	37,575	37,575	21,875
1990-94	39,165	39,165	21,915	0	0	0	1,590	1,590	894	37,575	37,575	21,021

149

TABLE NO. 12  
 ANNUAL ACCOUNTING OF EXTRactions BY AGUA MANSA WATER COMPANY AND MEEKS & DALEY WATER COMPANY  
 FROM THE SAN BERNARDINO BASIN AREA  
 FOR DELIVERY TO EACH SERVICE AREA  
 FIVE-YEAR TOTALS

(All Values in Acre-Feet)

Five-Year Period	Verified Extractions from the San Bernardino Basin Area			Delivery for Use in San Bernardino Basin Area			Delivery for Use in Colton Basin Area and Riverside Basin Area in San Bernardino County			Delivery for Use in Areas Outside San Bernardino Valley		
	Adjusted Right <sup>1</sup>	Maximum Allowable <sup>2</sup>	Extractions <sup>3</sup>	Adjusted Right <sup>4</sup>	Maximum Allowable <sup>2</sup>	Deliveries <sup>3</sup>	Adjusted Right <sup>4</sup>	Maximum Allowable <sup>2</sup>	Deliveries <sup>3</sup>	Adjusted Right <sup>1</sup>	Maximum Allowable <sup>2</sup>	Deliveries <sup>3</sup>
1991-95	39,165	39,165	21,624	0	0	0	1,590	1,590	956	37,575	37,575	20,668
1992-96	39,165	39,165	21,110	0	0	0	1,590	1,590	960	37,575	37,575	20,150
1993-97	39,165	39,165	21,175	0	0	0	1,590	1,590	979	37,575	37,575	20,196
1994-98	39,165	39,165	19,990	0	0	0	1,590	1,590	913	37,575	37,575	19,077
1995-99	39,165	39,165	21,754	0	0	0	1,590	1,590	776	37,575	37,575	20,978
1996-00	39,165	39,165	22,026	0	0	0	1,590	1,590	983	37,575	37,575	21,043
1997-01	39,165	39,165	21,785	0	0	0	1,590	1,590	981	37,575	37,575	20,804
1998-02	39,165	39,165	23,420	0	0	0	1,590	1,590	1,046	37,575	37,575	22,374
1999-03	39,165	39,165	27,032	0	0	0	1,590	1,590	885	37,575	37,575	26,147
2000-04	39,165	39,165	24,525	0	0	0	1,590	1,590	814	37,575	37,575	23,711
2001-05	39,165	39,165	26,584	0	0	0	1,590	1,590	466	37,575	37,575	26,118
2002-06	39,165	39,165	30,428	0	0	0	1,590	1,590	274	37,575	37,575	30,154
2003-07	39,165	39,165	32,219	0	0	0	1,590	1,590	72	37,575	37,575	32,147
2004-08	39,165	39,165	29,611	0	0	0	1,590	1,590	23	37,575	37,575	29,588
2005-09	39,165	39,165	32,174	0	0	0	1,590	1,590	4	37,575	37,575	32,170
2006-10	39,165	39,165	33,021	0	0	0	1,590	1,590	0	37,575	37,575	33,021
2007-11	39,165	39,165	32,633	0	0	0	1,590	1,590	0	37,575	37,575	32,633
2008-12	39,165	39,165	32,159	0	0	0	1,590	1,590	0	37,575	37,575	32,159
2009-13	39,423	39,423	35,059	0	0	0	1,590	1,590	0	37,833	37,833	35,059
2010-14	39,681	39,681		0	0		1,590	1,590		38,091	38,091	

150

TABLE NO. 12  
 ANNUAL ACCOUNTING OF EXTRactions BY AGUA MANSA WATER COMPANY AND MEEKS & DALEY WATER COMPANY  
 FROM THE SAN BERNARDINO BASIN AREA  
 FOR DELIVERY TO EACH SERVICE AREA  
 FIVE-YEAR TOTALS

(All Values in Acre-Feet)

Five-Year Period	Verified Extractions from the San Bernardino Basin Area			Delivery for Use in San Bernardino Basin Area			Delivery for Use in Colton Basin Area and Riverside Basin Area in San Bernardino County			Delivery for Use in Areas Outside San Bernardino Valley		
	Adjusted Right <sup>1</sup>	Maximum Allowable <sup>2</sup>	Extractions <sup>3</sup>	Adjusted Right <sup>4</sup>	Maximum Allowable <sup>2</sup>	Deliveries <sup>3</sup>	Adjusted Right <sup>4</sup>	Maximum Allowable <sup>2</sup>	Deliveries <sup>3</sup>	Adjusted Right <sup>1</sup>	Maximum Allowable <sup>2</sup>	Deliveries <sup>3</sup>
2011-15	39,939	39,939		0	0		1,590	1,590		38,349	38,349	
2012-16	40,197	40,197		0	0		1,590	1,590		38,607	38,607	
2013-17	40,455	40,455		0	0		1,590	1,590		38,865	38,865	
2014-18	40,455	40,455		0	0		1,590	1,590		38,865	38,865	
2015-19	40,455	40,455		0	0		1,590	1,590		38,865	38,865	
2016-20	40,455	40,455		0	0		1,590	1,590		38,865	38,865	
Excess Extractions												
2009-13		(4,364) *			0 *			(1,590) *			(2,774) *	

\* Parentheses indicate that Extractions and Deliveries are less than Adjusted Right.

1 Adjusted Right equals Safe Yield Adjusted Right plus New Conservation Allocation.

2 Maximum allowable for the five-year period is the same as the five-year-period Adjusted Right.

3 Extractions and Deliveries from Table No. 3C-2.

4 New Conservation Allocation may also be used in the San Bernardino Basin Area, or the Colton Basin Area and Riverside Basin Area in San Bernardino County.

151

TABLE NO. 12A  
 ALLOWABLE EXTRACTIONS BY AGUA MANSA WATER COMPANY AND MEEKS & DALEY WATER COMPANY  
 FROM THE SAN BERNARDINO BASIN AREA  
 FOR DELIVERY TO EACH SERVICE AREA

CALENDAR YEAR 2014  
 (All Values in Acre-Feet)

		<u>Allowable Total Extractions from the San Bernardino Basin Area</u>	<u>Allowable Delivery for Use in San Bernardino Basin Area</u>	<u>Allowable Delivery for Use in Colton Basin Area and Riverside Basin Area in San Bernardino County</u>	<u>Allowable Delivery for Use in Areas Outside San Bernardino Valley</u>
Allowable Extraction Based on Adjusted Right	<b>1</b>	9,790	0	413	9,377
Imported Water Available In Holding Account	<b>2</b>	0	See Footnote <b>5</b>	See Footnote <b>5</b>	0
New Conservation Water Available	<b>3</b>	1,448	See Footnote <b>6</b>	See Footnote <b>6</b>	1,448
Total Allowable Extraction	<b>4</b>	11,238	0	413	10,825



TABLE NO. 12A  
ALLOWABLE EXTRACTIONS BY AGUA MANSA WATER COMPANY AND MEEKS & DALEY WATER COMPANY  
FROM THE SAN BERNARDINO BASIN AREA  
FOR DELIVERY TO EACH SERVICE AREA

CALENDAR YEAR 2014  
(All Values in Acre-Feet)

- 1 *Component of Total Allowable Extractions available through the adjusted right which is equal to the 1959-63 base period extractions minus an adjustment for safe yield and plus an adjustment to include new conservation water forecast to result from long term operation of Seven Oaks Reservoir and diversion of increased amounts for recharge at the Santa Ana River Spreading Grounds. The Allowable Delivery amounts are the adjusted right for the five year period ending with the subject year minus the sum of the Deliveries (Table 12, Page 1 of 3) for the previous four years or the Maximum Allowable annual delivery (1.3 times average annual allowable delivery) whichever is the lessor. Allowable Total Extractions is the sum of the allowable deliveries.*
- 2 *Component of Total Allowable Extraction available if Western has previously transferred to Agua Mansa Water Company and Meeks & Daley Water Company the right to extract imported water and Agua Mansa Water Company and Meeks & Daley Water Company has under extracted water in an amount equal to or less than the sum of the rights to extract that were previously transferred. The amount available for extraction by Agua Mansa Water Company and Meeks & Daley Water Company is accounted for in Table No. 17B-3, and is referred to as Imported Water Net Accumulated (Credit).*
- 3 *Component of Total Allowable Extraction available as a result of Western, San Bernardino Valley and the Riverside Court approving a Judgment Paragraph VI (b) 6 agreement providing an allocation of new conservation water determined by Watermaster to have resulted from operation of Seven Oaks Reservoir from 1998 through 2012 and any future Judgment Paragraph VI (b) 6 agreement allocating new conservation water determined by Watermaster to have resulted from a future hydrologic event that resulted in direct use of Seven Oaks water or recharge of the San Bernardino Basin Area with Seven Oaks water in areas other than the Santa Ana River Spreading Grounds provided the capability to recharge at the Spreading Grounds has been fully utilized. The amount available for extraction by Agua Mansa Water Company and Meeks & Daley Water Company is accounted for in Table No. 17B-3, and is referred to as New Conservation Net Accumulated (Credit).*
- 4 *The Total Allowable Extraction is the sum of the allowable components described in Footnotes 1, 2 and 3.*
- 5 *Watermaster anticipates that Agua Mansa Water Company and Meeks & Daley Water Company will not have excess extractions for delivery in the San Bernardino Basin Area or in the Colton and Riverside Basin Areas in San Bernardino County and therefore it is unlikely that Western will transfer a right to extract imported water for delivery in these areas. Therefore, it is unlikely that imported water resulting from under extractions will become available to Agua Mansa Water Company and Meeks & Daley Water Company for delivery in these areas. However, if transfers of imported water and under extractions do occur, Watermaster will account for such occurrences at that time.*
- 6 *Watermaster anticipates that Agua Mansa Water Company and Meeks & Daley Water Company will not have excess extractions for delivery in the San Bernardino Basin Area or in the Colton and Riverside Basin Areas in San Bernardino County and therefore Agua Mansa Water Company and Meeks & Daley Water Company is unlikely to choose to use its allocation of new conservation water for deliveries in these areas. However, if excess extractions occur in these areas, Agua Mansa Water Company and Meeks & Daley Water Company will likely choose to use its new conservation allocation to address the excess extraction and Watermaster will account for such use at that time.*

TABLE NO. 13  
 ANNUAL ACCOUNTING OF EXTRACTIONS BY THE REGENTS OF THE UNIVERSITY OF CALIFORNIA  
 FROM THE SAN BERNARDINO BASIN AREA  
 FOR DELIVERY TO EACH SERVICE AREA  
 ANNUAL TOTALS

(All Values in Acre-Feet)

Calendar Year	Verified Extractions from the San Bernardino Basin Area			Delivery for Use in San Bernardino Basin Area			Delivery for Use in Colton Basin Area and Riverside Basin Area in San Bernardino County			Delivery for Use in Areas Outside San Bernardino Valley		
	Adjusted Right <sup>1</sup>	Maximum Allowable <sup>2</sup>	Extractions <sup>3</sup>	Adjusted Right <sup>4</sup>	Maximum Allowable <sup>2</sup>	Deliveries <sup>3</sup>	Adjusted Right <sup>4</sup>	Maximum Allowable <sup>2</sup>	Deliveries <sup>3</sup>	Adjusted Right <sup>1</sup>	Maximum Allowable <sup>2</sup>	Deliveries <sup>3</sup>
1971	581	755	219	0	0	0	0	0	0	581	755	219
1972	536	697	239	0	0	0	0	0	0	536	697	239
1973	536	697	239	0	0	0	0	0	0	536	697	239
1974	536	697	267	0	0	0	0	0	0	536	697	267
1975	536	697	179	0	0	0	0	0	0	536	697	179
1976	536	697	245	0	0	0	0	0	0	536	697	245
1977	536	697	87	0	0	0	0	0	0	536	697	87
1978	536	697	183	0	0	0	0	0	0	536	697	183
1979	536	697	83	0	0	0	0	0	0	536	697	83
1980	536	697	7	0	0	0	0	0	0	536	697	7
1981	536	697	143	0	0	0	0	0	0	536	697	143
1982	536	697	48	0	0	0	0	0	0	536	697	48
1983	536	697	0	0	0	0	0	0	0	536	697	0
1984	536	697	0	0	0	0	0	0	0	536	697	0
1985	536	697	0	0	0	0	0	0	0	536	697	0
1986	536	697	48	0	0	0	0	0	0	536	697	48
1987	536	697	195	0	0	0	0	0	0	536	697	195
1988	536	697	179	0	0	0	0	0	0	536	697	179
1989	536	697	62	0	0	0	0	0	0	536	697	62
1990	536	697	95	0	0	0	0	0	0	536	697	95

154

TABLE NO. 13  
 ANNUAL ACCOUNTING OF EXTRACTIONS BY THE REGENTS OF THE UNIVERSITY OF CALIFORNIA  
 FROM THE SAN BERNARDINO BASIN AREA  
 FOR DELIVERY TO EACH SERVICE AREA  
 ANNUAL TOTALS

(All Values in Acre-Feet)

Calendar Year	Verified Extractions from the San Bernardino Basin Area			Delivery for Use in San Bernardino Basin Area			Delivery for Use in Colton Basin Area and Riverside Basin Area in San Bernardino County			Delivery for Use in Areas Outside San Bernardino Valley		
	Adjusted Right <sup>1</sup>	Maximum Allowable <sup>2</sup>	Extractions <sup>3</sup>	Adjusted Right <sup>4</sup>	Maximum Allowable <sup>2</sup>	Deliveries <sup>3</sup>	Adjusted Right <sup>4</sup>	Maximum Allowable <sup>2</sup>	Deliveries <sup>3</sup>	Adjusted Right <sup>1</sup>	Maximum Allowable <sup>2</sup>	Deliveries <sup>3</sup>
1991	536	697	23	0	0	0	0	0	0	536	697	23
1992	536	697	32	0	0	0	0	0	0	536	697	32
1993	536	697	0	0	0	0	0	0	0	536	697	0
1994	536	697	0	0	0	0	0	0	0	536	697	0
1995	536	697	0	0	0	0	0	0	0	536	697	0
1996	536	697	445	0	0	0	0	0	0	536	697	445
1997	536	697	447	0	0	0	0	0	0	536	697	447
1998	536	697	536	0	0	0	0	0	0	536	697	536
1999	536	697	536	0	0	0	0	0	0	536	697	536
2000	536	697	536	0	0	0	0	0	0	536	697	536
2001	536	697	536	0	0	0	0	0	0	536	697	536
2002	536	697	536	0	0	0	0	0	0	536	697	536
2003	536	697	536	0	0	0	0	0	0	536	697	536
2004	536	697	536	0	0	0	0	0	0	536	697	536
2005	536	697	536	0	0	0	0	0	0	536	697	536
2006	536	697	536	0	0	0	0	0	0	536	697	536
2007	536	697	536	0	0	0	0	0	0	536	697	536
2008	536	697	536	0	0	0	0	0	0	536	697	536
2009	536	697	536	0	0	0	0	0	0	536	697	536
2010	536	697	536	0	0	0	0	0	0	536	697	536

155

TABLE NO. 13  
 ANNUAL ACCOUNTING OF EXTRACTIONS BY THE REGENTS OF THE UNIVERSITY OF CALIFORNIA  
 FROM THE SAN BERNARDINO BASIN AREA  
 FOR DELIVERY TO EACH SERVICE AREA  
 ANNUAL TOTALS

(All Values in Acre-Feet)

Calendar Year	Verified Extractions from the San Bernardino Basin Area			Delivery for Use in San Bernardino Basin Area			Delivery for Use in Colton Basin Area and Riverside Basin Area in San Bernardino County			Delivery for Use in Areas Outside San Bernardino Valley		
	Adjusted Right <sup>1</sup>	Maximum Allowable <sup>2</sup>	Extractions <sup>3</sup>	Adjusted Right <sup>4</sup>	Maximum Allowable <sup>2</sup>	Deliveries <sup>3</sup>	Adjusted Right <sup>4</sup>	Maximum Allowable <sup>2</sup>	Deliveries <sup>3</sup>	Adjusted Right <sup>1</sup>	Maximum Allowable <sup>2</sup>	Deliveries <sup>3</sup>
2011	536	697	536	0	0	0	0	0	0	536	697	536
2012	536	697	536	0	0	0	0	0	0	536	697	536
2013	554	720	536	0	0	0	0	0	0	554	720	536
2014	554	720		0	0		0	0		554	720	
2015	554	720		0	0		0	0		554	720	
2016	554	720		0	0		0	0		554	720	
2017	554	720		0	0		0	0		554	720	
2018	554	720		0	0		0	0		554	720	
2019	554	720		0	0		0	0		554	720	
2020	554	720		0	0		0	0		554	720	

See Report of Watermaster, Tables 3D-1 and 3D-2.

<sup>1</sup> Adjusted Right equals Safe Yield Adjusted Right plus New Conservation Allocation.

<sup>2</sup> Maximum Allowable for any one year, not to exceed 130% of Adjusted Right.

<sup>3</sup> Extractions and Deliveries from Table No. 3D-2. (Volume 1A, Table 3)

<sup>4</sup> New Conservation Allocation may also be used in the San Bernardino Basin Area, or the Colton Basin Area and Riverside Basin Area in San Bernardino County.

Note: Annual Accounting of Extractions as required in Paragraphs V and VI of the Judgment.

156

TABLE NO. 13  
 ANNUAL ACCOUNTING OF EXTRACTIONS BY THE REGENTS OF THE UNIVERSITY OF CALIFORNIA  
 FROM THE SAN BERNARDINO BASIN AREA  
 FOR DELIVERY TO EACH SERVICE AREA  
 FIVE-YEAR TOTALS

(All Values in Acre-Feet)

Five-Year Period	Verified Extractions from the San Bernardino Basin Area			Delivery for Use in San Bernardino Basin Area			Delivery for Use in Colton Basin Area and Riverside Basin Area in San Bernardino County			Delivery for Use in Areas Outside San Bernardino Valley		
	Adjusted Right <sup>1</sup>	Maximum Allowable <sup>2</sup>	Extractions <sup>3</sup>	Adjusted Right <sup>4</sup>	Maximum Allowable <sup>2</sup>	Deliveries <sup>3</sup>	Adjusted Right <sup>4</sup>	Maximum Allowable <sup>2</sup>	Deliveries <sup>3</sup>	Adjusted Right <sup>1</sup>	Maximum Allowable <sup>2</sup>	Deliveries <sup>3</sup>
1971-75	2,725	2,725	1,143	0	0	0	0	0	0	2,725	2,725	1,143
1972-76	2,680	2,680	1,169	0	0	0	0	0	0	2,680	2,680	1,169
1973-77	2,680	2,680	1,017	0	0	0	0	0	0	2,680	2,680	1,017
1974-78	2,680	2,680	961	0	0	0	0	0	0	2,680	2,680	961
1975-79	2,680	2,680	777	0	0	0	0	0	0	2,680	2,680	777
1976-80	2,680	2,680	605	0	0	0	0	0	0	2,680	2,680	605
1977-81	2,680	2,680	503	0	0	0	0	0	0	2,680	2,680	503
1978-82	2,680	2,680	464	0	0	0	0	0	0	2,680	2,680	464
1979-83	2,680	2,680	281	0	0	0	0	0	0	2,680	2,680	281
1980-84	2,680	2,680	198	0	0	0	0	0	0	2,680	2,680	198
1981-85	2,680	2,680	191	0	0	0	0	0	0	2,680	2,680	191
1982-86	2,680	2,680	96	0	0	0	0	0	0	2,680	2,680	96
1983-87	2,680	2,680	243	0	0	0	0	0	0	2,680	2,680	243
1984-88	2,680	2,680	422	0	0	0	0	0	0	2,680	2,680	422
1985-89	2,680	2,680	484	0	0	0	0	0	0	2,680	2,680	484
1986-90	2,680	2,680	579	0	0	0	0	0	0	2,680	2,680	579
1987-91	2,680	2,680	554	0	0	0	0	0	0	2,680	2,680	554
1988-92	2,680	2,680	391	0	0	0	0	0	0	2,680	2,680	391
1989-93	2,680	2,680	212	0	0	0	0	0	0	2,680	2,680	212
1990-94	2,680	2,680	150	0	0	0	0	0	0	2,680	2,680	150

157

TABLE NO. 13  
 ANNUAL ACCOUNTING OF EXTRACTIONS BY THE REGENTS OF THE UNIVERSITY OF CALIFORNIA  
 FROM THE SAN BERNARDINO BASIN AREA  
 FOR DELIVERY TO EACH SERVICE AREA  
 FIVE-YEAR TOTALS

(All Values in Acre-Feet)

Five-Year Period	Verified Extractions from the San Bernardino Basin Area			Delivery for Use in San Bernardino Basin Area			Delivery for Use in Colton Basin Area and Riverside Basin Area in San Bernardino County			Delivery for Use in Areas Outside San Bernardino Valley		
	Adjusted Right <sup>1</sup>	Maximum Allowable <sup>2</sup>	Extractions <sup>3</sup>	Adjusted Right <sup>4</sup>	Maximum Allowable <sup>2</sup>	Deliveries <sup>3</sup>	Adjusted Right <sup>4</sup>	Maximum Allowable <sup>2</sup>	Deliveries <sup>3</sup>	Adjusted Right <sup>1</sup>	Maximum Allowable <sup>2</sup>	Deliveries <sup>3</sup>
1991-95	2,680	2,680	55	0	0	0	0	0	0	2,680	2,680	55
1992-96	2,680	2,680	477	0	0	0	0	0	0	2,680	2,680	477
1993-97	2,680	2,680	892	0	0	0	0	0	0	2,680	2,680	892
1994-98	2,680	2,680	1,428	0	0	0	0	0	0	2,680	2,680	1,428
1995-99	2,680	2,680	1,964	0	0	0	0	0	0	2,680	2,680	1,964
1996-00	2,680	2,680	2,500	0	0	0	0	0	0	2,680	2,680	2,500
1997-01	2,680	2,680	2,591	0	0	0	0	0	0	2,680	2,680	2,591
1998-02	2,680	2,680	2,680	0	0	0	0	0	0	2,680	2,680	2,680
1999-03	2,680	2,680	2,680	0	0	0	0	0	0	2,680	2,680	2,680
2000-04	2,680	2,680	2,680	0	0	0	0	0	0	2,680	2,680	2,680
2001-05	2,680	2,680	2,680	0	0	0	0	0	0	2,680	2,680	2,680
2002-06	2,680	2,680	2,680	0	0	0	0	0	0	2,680	2,680	2,680
2003-07	2,680	2,680	2,680	0	0	0	0	0	0	2,680	2,680	2,680
2004-08	2,680	2,680	2,680	0	0	0	0	0	0	2,680	2,680	2,680
2005-09	2,680	2,680	2,680	0	0	0	0	0	0	2,680	2,680	2,680
2006-10	2,680	2,680	2,680	0	0	0	0	0	0	2,680	2,680	2,680
2007-11	2,680	2,680	2,680	0	0	0	0	0	0	2,680	2,680	2,680
2008-12	2,680	2,680	2,680	0	0	0	0	0	0	2,680	2,680	2,680
2009-13	2,698	2,698	2,680	0	0	0	0	0	0	2,698	2,698	2,680
2010-14	2,716	2,716		0	0		0	0		2,716	2,716	

158

TABLE NO. 13  
 ANNUAL ACCOUNTING OF EXTRACTIONS BY THE REGENTS OF THE UNIVERSITY OF CALIFORNIA  
 FROM THE SAN BERNARDINO BASIN AREA  
 FOR DELIVERY TO EACH SERVICE AREA  
 FIVE-YEAR TOTALS

(All Values in Acre-Feet)

Five-Year Period	Verified Extractions from the San Bernardino Basin Area			Delivery for Use in San Bernardino Basin Area			Delivery for Use in Colton Basin Area and Riverside Basin Area in San Bernardino County			Delivery for Use in Areas Outside San Bernardino Valley		
	Adjusted Right <sup>1</sup>	Maximum Allowable <sup>2</sup>	Extractions <sup>3</sup>	Adjusted Right <sup>4</sup>	Maximum Allowable <sup>2</sup>	Deliveries <sup>4</sup>	Adjusted Right <sup>1</sup>	Maximum Allowable <sup>2</sup>	Deliveries <sup>3</sup>	Adjusted Right <sup>1</sup>	Maximum Allowable <sup>2</sup>	Deliveries <sup>3</sup>
2011-15	2,734	2,734		0	0		0	0		2,734	2,734	
2012-16	2,752	2,752		0	0		0	0		2,752	2,752	
2013-17	2,770	2,770		0	0		0	0		2,770	2,770	
2014-18	2,770	2,770		0	0		0	0		2,770	2,770	
2015-19	2,770	2,770		0	0		0	0		2,770	2,770	
2016-20	2,770	2,770		0	0		0	0		2,770	2,770	
Excess Extractions 2009-13		(18) *			0 *			0 *			(18) *	

\* Parentheses indicate that Extractions and Deliveries are less than Adjusted Right.

1 Adjusted Right equals Safe Yield Adjusted Right plus New Conservation Allocation.

2 Maximum allowable for the five-year period is the same as the five-year-period Adjusted Right.

3 Extractions and Deliveries from Table No. 3D-2. (Volume 1A, Table 3)

4 New Conservation Allocation may also be used in the San Bernardino Basin Area, or the Colton Basin Area and Riverside Basin Area in San Bernardino County.

159

TABLE NO. 13A  
 ALLOWABLE EXTRACTIONS BY THE REGENTS OF THE UNIVERSITY OF CALIFORNIA  
 FROM THE SAN BERNARDINO BASIN AREA  
 FOR DELIVERY TO EACH SERVICE AREA

CALENDAR YEAR 2014  
 (All Values in Acre-Feet)

		<u>Allowable Total Extractions from the San Bernardino Basin Area</u>	<u>Allowable Delivery for Use in San Bernardino Basin Area</u>	<u>Allowable Delivery for Use in Colton Basin Area and Riverside Basin Area in San Bernardino County</u>	<u>Allowable Delivery for Use in Areas Outside San Bernardino Valley</u>
Allowable Extraction Based on Adjusted Right	1	572	0	0	572
Imported Water Available In Holding Account	2	0	See Footnote 5	See Footnote 5	0
New Conservation Water Available	3	<u>98</u>	<u>See Footnote 6</u>	<u>See Footnote 6</u>	<u>98</u>
Total Allowable Extraction	4	670	0	0	670



TABLE NO. 13A  
ALLOWABLE EXTRACTIONS BY THE REGENTS OF THE UNIVERSITY OF CALIFORNIA  
FROM THE SAN BERNARDINO BASIN AREA  
FOR DELIVERY TO EACH SERVICE AREA

CALENDAR YEAR 2014  
(All Values in Acre-Feet)

- 1 *Component of Total Allowable Extractions available through the adjusted right which is equal to the 1959-63 base period extractions minus an adjustment for safe yield and plus an adjustment to include new conservation water forecast to result from long term operation of Seven Oaks Reservoir and diversion of increased amounts for recharge at the Santa Ana River Spreading Grounds. The Allowable Delivery amounts are the adjusted right for the five year period ending with the subject year minus the sum of the Deliveries (Table 13, Page 1 of 3) for the previous four years or the Maximum Allowable annual delivery (1.3 times average annual allowable delivery) whichever is the lessor. Allowable Total Extractions is the sum of the allowable deliveries.*
- 2 *Component of Total Allowable Extraction available if Western has previously transferred to The Regents of the University of California the right to extract imported water and the Regents of the University of California has under extracted water in an amount equal to or less than the sum of the rights to extract that were previously transferred. The amount available for extraction by The Regents of the University of California is accounted for in Table No. 17B-4, and is referred to as Imported Water Net Accumulated (Credit).*
- 3 *Component of Total Allowable Extraction available as a result of Western, San Bernardino Valley and the Riverside Court approving a Judgment Paragraph VI (b) 6 agreement providing an allocation of new conservation water determined by Watermaster to have resulted from operation of Seven Oaks Reservoir from 1998 through 2012 and any future Judgment Paragraph VI (b) 6 agreement allocating new conservation water determined by Watermaster to have resulted from a future hydrologic event that resulted in direct use of Seven Oaks water or recharge of the San Bernardino Basin Area with Seven Oaks water in areas other than the Santa Ana River Spreading Grounds provided the capability to recharge at the Spreading Grounds has been fully utilized. The amount available for extraction by The Regents of the University of California is accounted for in Table No. 17B-4, and is referred to as New Conservation Net Accumulated (Credit).*
- 4 *The Total Allowable Extraction is the sum of the allowable components described in Footnotes 1, 2 and 3.*
- 5 *Watermaster anticipates that The Regents of the University of California will not have excess extractions for delivery in the San Bernardino Basin Area or in the Colton and Riverside Basin Areas in San Bernardino County and therefore it is unlikely that Western will transfer a right to extract imported water for delivery in these areas. Therefore, it is unlikely that imported water resulting from under extractions will become available to The Regents of the University of California for delivery in these areas. However, if transfers of imported water and under extractions do occur, Watermaster will account for such occurrences at that time.*
- 6 *Watermaster anticipates that The Regents of the University of California will not have excess extractions for delivery in the San Bernardino Basin Area or in the Colton and Riverside Basin Areas in San Bernardino County and therefore The Regents of the University of California is unlikely to choose to use its allocation of new conservation water for deliveries in these areas. However, if excess extractions occur in these areas, The Regents of the University of California will likely choose to use its new conservation allocation to address the excess extraction and Watermaster will account for such use at that time.*

TABLE NO. 14

ANNUAL ACCOUNTING FOR  
WESTERN MUNICIPAL WATER DISTRICT  
EXPORT OF EXTRACTIONS FROM SAN BERNARDINO BASIN AREA,  
COLTON BASIN AREA, AND RIVERSIDE BASIN AREA  
FOR USE WITHIN WESTERN ON LANDS THAT ARE NOT TRIBUTARY  
TO THE RIVERSIDE NARROWS  
(All Values in Acre-Feet)

		Calendar Years				
		2009	2010	2011	2012	2013
<b>EXPORTS</b>						
Annual 1959-63 Average		42,535	42,535	42,535	42,535	42,535
Actual Export	1	39,101	38,229	40,848	40,088	41,906
<b>ACCUMULATED EXPORT</b>	2	1,521,455	1,559,684	1,600,532	1,640,620	1,682,526
<b>OBLIGATIONS</b>						
Total New Export	3	(3,434)	(4,306)	(1,687)	(2,447)	(629)
Additional New Export	4	0	0	0	0	0
New Export	5	(3,434)	(4,306)	(1,687)	(2,447)	(629)
<b>ACCUMULATED NEW EXPORT</b>	2	(314,617)	(318,923)	(320,610)	(323,057)	(323,686)

1 See Table 8 of Watermaster Report. (Data from Volume 6, Table A.)

2 Accumulated values include amounts accumulated prior to current 5-year period.

3 Actual Export minus Annual 1959-63 Average. (Parentheses indicate that Actual Export is less than Annual 1959-63 Average.)

4 New Export which was allowed under High Groundwater Mitigation agreements without replenishment obligation.

5 Total New Export minus Additional New Export.

TABLE NO. 15A

ANNUAL ACCOUNTING FOR  
 SAN BERNARDINO VALLEY MUNICIPAL WATER DISTRICT  
 EXPORT OF EXTRACTIONS FROM SAN BERNARDINO BASIN AREA  
 FOR USE ON LANDS  
 NOT WITHIN WESTERN NOR TRIBUTARY  
 TO THE RIVERSIDE NARROWS

(All Values in Acre-Feet)  
 Calendar Years

		2009	2010	2011	2012	2013
<b>EXPORTS</b>						
Annual 1959-63 Average	1	11,701	11,701	11,701	11,701	11,701
Actual Export	1	22,041	25,317	34,687	22,944	15,559
<b>ACCUMULATED EXPORT</b>	2	894,363	919,680	954,367	977,311	992,870
<b>OBLIGATIONS</b>						
Total New Export	3	10,340	13,616	22,986	11,243	3,858
Additional New Export	4	0	0	0	0	0
New Export	5	10,340	13,616	22,986	11,243	3,858
<b>ACCUMULATED NEW EXPORT</b>	2	242,415	256,031	279,017	290,260	294,118

1 See Table No. 9A. (Data from Volume 7, Tables C and D)

2 Accumulated values include amounts accumulated prior to current 5-year period.

3 Actual Export minus Annual 1959-63 Average. (Parentheses indicate that Actual Export is less than Annual 1959-63 Average)

4 New Export which was allowed under High Groundwater Mitigation agreements without replenishment obligation.

5 Total New Export minus Additional New Export.

TABLE NO. 15B

ANNUAL ACCOUNTING FOR  
 SAN BERNARDINO VALLEY MUNICIPAL WATER DISTRICT  
 DELIVERY OF EXTRACTIONS FROM SAN BERNARDINO BASIN AREA  
 FOR USE ON LANDS  
 WITHIN COLTON AND RIVERSIDE BASIN AREAS

(All Values in Acre-Feet)  
 Calendar Years

DELIVERIES		2009	2010	2011	2012	2013
Annual 1959-63 Average	1	17,837	17,837	17,837	17,837	17,837
Actual Deliveries	1	27,651	20,564	21,573	23,560	22,926
<b>ACCUMULATED DELIVERIES</b>	<b>2</b>	<b>872,369</b>	<b>892,933</b>	<b>914,506</b>	<b>938,066</b>	<b>960,992</b>
<b>OBLIGATIONS</b>						
Total New Deliveries	3	9,814	2,727	3,736	5,723	5,089
Additional New Deliveries	4	0	0	0	0	0
New Deliveries	5	9,814	2,727	3,736	5,723	5,089
<b>ACCUMULATED NEW DELIVERIES</b>	<b>2</b>	<b>122,946</b>	<b>125,673</b>	<b>129,409</b>	<b>135,132</b>	<b>140,221</b>

1 See Table No. 9B. (Data from Volume 7, Tables E and F)

2 Accumulated values include amounts accumulated prior to current 5-year period.

3 Actual Deliveries minus Annual 1959-63 Average. (Parentheses indicate that Actual Deliveries are less than Annual 1959-63 Average)

4 New Deliveries which were allowed under High Groundwater Mitigation agreements without replenishment obligation.

5 Total New Deliveries minus Additional New Deliveries.

ANNUAL ACCOUNTING FOR  
WESTERN MUNICIPAL WATER DISTRICT  
EXTRACTIONS FROM COLTON BASIN AREA AND  
RIVERSIDE BASIN AREA  
WITHIN RIVERSIDE AND SAN BERNARDINO COUNTIES  
FOR USE OUTSIDE SAN BERNARDINO VALLEY  
(All Values in Acre-Feet)

		Calendar Years				
		2009	2010	2011	2012	2013
<b>EXTRACTIONS</b>						
<b>Base Period 1959-1963</b>						
Colton Basin Area	1	3,381	3,381	3,381	3,381	3,381
Riverside Basin Area Within San Bernardino County	2	21,085	21,085	21,085	21,085	21,085
Riverside Basin Area Within Riverside County	3	29,633	29,633	29,633	29,633	29,633
Total Extractions 1959-1963		54,099	54,099	54,099	54,099	54,099
<b>Current Period 2009-2013</b>						
Colton Basin Area	1	378	77	173	74	81
Riverside Basin Area Within San Bernardino County	2	16,792	12,675	13,276	15,613	12,600
Riverside Basin Area Within Riverside County	3	35,519	29,077	30,510	28,049	30,070
Total Extractions 2009-2013		52,689	41,829	43,959	43,736	42,751
New Export	4	(3,434)	(4,306)	(1,687)	(2,447)	(629)
Total Extractions Excluding New Export	5	56,123	46,135	45,646	46,183	43,380
Under Extractions Excluding New Export	6	0	7,964	8,453	7,916	10,719
Excess Extractions Excluding New Export	7	2,024	0	0	0	0
<b>CREDITS</b>						
Extraction Credit	8	0	7,964	8,453	7,916	10,719
Return From Excess Extractions	9	729	0	0	0	0
New Export Credit	10	3,434	4,306	1,687	2,447	629
Replenishment	11	0	0	0	0	0
Storm Flow Conservation	12	0	0	0	0	0
Return from Imported Water	13	2,354	2,182	2,484	2,356	2,215
Return from New Conservation	14	0	0	0	0	769
Total Credits		6,517	14,452	12,624	12,719	14,332
ACCUMULATED CREDITS	15	545,420	559,872	572,496	585,215	599,547
<b>OBLIGATIONS</b>						
Extraction Obligation	16	2,024	0	0	0	0
Return from Under Extractions	17	0	2,867	3,043	2,850	3,859
New Export Obligation	18	0	0	0	0	0
Land Use Conversion	19	579	579	579	579	579
Total Obligations		2,603	3,446	3,622	3,429	4,438
ACCUMULATED OBLIGATIONS	15	130,219	133,665	137,287	140,716	145,154
(CREDIT) OR OBLIGATION	20	(3,914)	(11,006)	(9,002)	(9,290)	(9,894)
<b>NET ACCUMULATED (CREDIT) OR OBLIGATION</b>	15	(415,201)	(426,207)	(435,209)	(444,499)	(454,393)

ANNUAL ACCOUNTING FOR  
WESTERN MUNICIPAL WATER DISTRICT  
EXTRACTIONS FROM COLTON BASIN AREA AND  
RIVERSIDE BASIN AREA  
WITHIN RIVERSIDE AND SAN BERNARDINO COUNTIES  
FOR USE OUTSIDE SAN BERNARDINO VALLEY

- 1 See Table 4 of Watermaster Report
- 2 See Table 5 of Watermaster Report
- 3 See Table 6 of Watermaster Report
- 4 See Table 14 of Watermaster Report
- 5 Equals Total Extractions 2009-2013 minus New Export
- 6 Total Extractions 1959-1963 minus Total Extractions 2009-2013 Excluding New Export, if positive
- 7 Total Extractions 2009-2013 Excluding New Export minus Total Extractions 1959-1963, if positive
- 8 Amounts which may be extracted without replenishment obligation, which in fact are not extracted. Equals Under Extractions Excluding New Export.
- 9 Return from Excess Extractions equals 36% of Extraction Obligation
- 10 New Export Credit equals New Export, if negative
- 11 Imported water recharged in Colton Basin Area, Riverside Basin Area Within San Bernardino County, or Riverside Basin Area Within Riverside County
- 12 Credit for storm flows conserved between Bunker Hill Dike and Riverside Narrows, by Western entities, which would not otherwise contribute to base flow at Riverside Narrows, pursuant to Paragraph XI(b)3 of Judgment.
- 13 Return from Imported Water equals 36% of the quality adjusted amount of the imported water delivered directly to users and/or extracted from the San Bernardino Basin Area for use within Western pursuant to the August 18, 2004 Agreement and any other Judgment Paragraph VI(b)6 agreement that allows Western to extract additional water from the Basin as a result of purchasing imported water for recharge of the Basin. See Report of Watermaster, Volume 6, Table No. 11.
- 14 Return from New Conservation equals 36% of New Conservation. See Tables 3A-1, 3A-2, 3B-1, 3B-2, 3C-1, 3C-2, 3D-1 and 3D-2 of Watermaster Report.
- 15 Accumulated values include amounts accumulated prior to current 5-year period
- 16 Equals Excess Extractions Excluding New Export
- 17 Return from Under Extractions equals 36% of Extraction Credit
- 18 New Export Obligation equals New Export, if positive
- 19 See Table 7 of Watermaster Report
- 20 Net Credit or Obligation for this calendar year.

ANNUAL ACCOUNTING FOR  
SAN BERNARDINO VALLEY MUNICIPAL WATER DISTRICT  
EXTRACTIONS FROM SAN BERNARDINO BASIN AREA

(All Values in Acre-Feet)

		Calendar Years				
		2009	2010	2011	2012	2013
<b>EXTRACTIONS</b>						
Adjusted Right	1	167,238	167,238	167,238	167,238	172,745
Extractions	1	179,077	166,274	173,544	177,201	145,601
New Export	2	10,340	13,616	22,986	11,243	3,858
New Deliveries to Colton Basin Area within San Bernardino Valley and Riverside Basin Area within San Bernardino County	3	9,814	2,727	3,736	5,723	5,089
Extractions Excluding New Export and New Deliveries	4	158,923	149,931	146,822	160,235	136,654
Under Extractions Excluding New Export and New Deliveries	5	8,315	17,307	20,416	7,003	36,091
Excess Extractions Excluding New Export and New Deliveries	6	0	0	0	0	0
<b>CREDITS</b>						
Extraction Credit	7	8,315	17,307	20,416	7,003	36,091
Return From Excess Extractions	8	0	0	0	0	0
New Export Credit	9	0	0	0	0	0
New Deliveries Credit	10	0	0	0	0	0
Replenishment	11	12,622	18,717	18,999	24,220	12,453
Return from Imported Water	12	1,249	0	138	411	1,136
Return from New Conservation	13	0	0	0	0	8,396
Total Credits		22,186	36,024	39,553	31,634	58,076
ACCUMULATED CREDITS	14	659,611	695,635	735,188	766,822	824,898
<b>OBLIGATIONS</b>						
Extraction Obligation	15	0	0	0	0	0
Return From Under Extractions	16	2,993	6,231	7,350	2,521	12,993
New Export Obligation	17	10,340	13,616	22,986	11,243	3,858
New Deliveries Obligation	18	9,814	2,727	3,736	5,723	5,089
Total Obligations		23,147	22,574	34,072	19,487	21,940
ACCUMULATED OBLIGATIONS	14	563,671	586,245	620,317	639,804	661,744
(CREDIT) OR OBLIGATION	19	961	(13,450)	(5,481)	(12,147)	(36,136)
<b>NET ACCUMULATED (CREDIT) OR OBLIGATION</b>	14	(95,940)	(109,390)	(114,871)	(127,018)	(163,154)

ANNUAL ACCOUNTING FOR  
SAN BERNARDINO VALLEY MUNICIPAL WATER DISTRICT  
EXTRACTIONS FROM SAN BERNARDINO BASIN AREA

- 1 See Table No. 2 of Watermaster Report.
- 2 See Table No. 15A of Watermaster Report.
- 3 See Table No. 15B of Watermaster Report.
- 4 Extractions minus New Export minus New Deliveries.
- 5 Adjusted Right minus Extractions Excluding New Export and New Deliveries, if positive.
- 6 Extractions Excluding New Export and New Deliveries minus Adjusted Right, if positive.
- 7 Amounts which may be extracted without replenishment obligation, which in fact are not extracted.  
Equals Under Extractions Excluding New Export and New Deliveries.
- 8 Return from Excess Extractions equals 36% of Extraction Obligation.
- 9 New Export Credit equals New Export, if negative.
- 10 New Deliveries Credit equals New Deliveries, if negative.
- 11 See Report of Watermaster, Volume 7, Table No. 21, Imported water recharged in SBBA.
- 12 Return from Imported Water equals 36% of directed delivered Imported Water excluding In-Lieu Deliveries to BVMWC. See Report of Watermaster, Volume 7, Table No. 22.
- 13 Return from New Conservation equals 36% of New Conservation. See Table No. 2 of Watermaster Report.
- 14 Accumulated values include amounts accumulated prior to current 5-year period.
- 15 Equals Excess Extractions Excluding New Export and New Deliveries.
- 16 Return from Under Extractions equals 36% of Extraction Credit.
- 17 New Export Obligation equals New Export, if positive.
- 18 New Deliveries Obligation equals New Deliveries, if positive.
- 19 Net Credit or Obligation for this calendar year.



ANNUAL ACCOUNTING FOR  
ADDITIONAL EXTRACTIONS OF IMPORTED WATER  
FROM SAN BERNARDINO BASIN AREA  
BY WESTERN MUNICIPAL WATER DISTRICT

(All Values in Acre-Feet)

		Calendar Years				
		2009	2010	2011	2012	2013
<b>ADDITIONAL EXTRACTIONS</b>						
Imported Water Acquired By Western	1	2,459	0	0	0	0
Additional Extractions	2	0	0	0	0	0
<b>CREDITS</b>						
Imported Water Acquired By Western	1	2,459 <i>d</i>	0	0	0	0
Plaintiff Transfers To Holding Account	3	0	0	0	0	2,459 <i>e</i>
Total Credits		2,459	0	0	0	2,459
<b>ACCUMULATED CREDITS</b>	4	8,459	8,459	8,459	8,459	10,918
<b>OBLIGATIONS</b>						
Western Additional Extractions	5	0	0	0	0	0
Western Transfers To Plaintiffs	6	0	0	0	0	0
Holding Account Transfers To Plaintiffs	7	0	0	0	0	0
Total Obligations		0	0	0	0	0
<b>ACCUMULATED OBLIGATIONS</b>	8	2,459	2,459	2,459	2,459	2,459
<b>(CREDIT) OR OBLIGATION</b>	9	(2,459)	0	0	0	(2,459)
<b>WESTERN NET ACCUMULATED (CREDIT) OR OBLIGATION</b>	10	(6,000)	(6,000)	(6,000)	(6,000)	(6,000)
<b>PLAINTIFF NET ACCUMULATED (CREDIT)</b>	11	0	0	0	0	(2,459)
<b>TOTAL NET ACCUMULATED (CREDIT) OR OBLIGATION</b>	12	(6,000)	(6,000)	(6,000)	(6,000)	(8,459)

ANNUAL ACCOUNTING FOR  
ADDITIONAL EXTRACTIONS OF IMPORTED WATER  
FROM SAN BERNARDINO BASIN AREA  
BY WESTERN MUNICIPAL WATER DISTRICT

- 1 *Amount of imported water acquired from San Bernardino Valley or MWDSC by Western, that is spread and stored in the San Bernardino Basin Area pursuant to Judgment Paragraph XV (a) and is available for extraction (recapture) by Western and Plaintiffs pursuant to Judgment Paragraph VI(b)6 agreements.*
  - 2 *Amount of extractions by Western and/or extractions by Plaintiffs of imported water acquired and stored in the San Bernardino Basin Area by Western and transferred to Plaintiffs.*
  - 3 *Sum of all Plaintiffs transfers to Western of amounts of water equal to Plaintiffs unused water right provided the amount transferred plus the remaining balance of any previous such transfers does not exceed the aggregate amount of imported water previously transferred by Western to the Plaintiffs (see Footnote 5 on Table Nos. 17 B-1 through 17 B-4).*
  - 4 *Accumulated Credits include amounts of credit accumulated prior to the current five year period.*
  - 5 *Amount of extractions made by Western of Imported Water Acquired By Western (see Footnote 1).*
  - 6 *Sum of the amounts of Imported Water Acquired By Western transferred to Plaintiffs for the purpose of allowing additional extractions by Plaintiffs (see Footnote 4 on Table Nos. 17 B-1 through 17 B-4).*
  - 7 *Sum of the amounts of water in the Western holding accounts for each Plaintiff that can be transferred to Plaintiffs for the purpose of allowing additional extractions by Plaintiff (see Footnote 8 on Table Nos. 17 B-1 through 17 B-4).*
  - 8 *Accumulated Obligations include extraction and transfer of right to extract related obligations accumulated for the current five year period and for prior years.*
  - 9 *(Credit) or Obligation equals Total Obligations minus Total Credits for the calendar year.*
  - 10 *Western Net Accumulated (Credit) or Obligation equals the sum of all annual Western Additional Extractions (see Footnote 5) plus all annual Western Transfers to Plaintiffs (see Footnote 6) minus the sum of all annual amounts of Imported Water Acquired by Western (see Footnote 1). Such credit allows extraction by Western and/or allows transfer of an additional right to extract to Plaintiffs. To the extent permitted by agreement with San Bernardino Valley, if extractions have been made prior to replenishment, the Western Net Accumulated Obligation reflects the amount of future replenishment that must be made.*
  - 11 *Plaintiff Net Accumulated (Credit) equals the sum of all Holding Account Transfers to Plaintiffs (see Footnote 7) minus the sum of all annual Plaintiff Transfers to Holding Accounts (see Footnote 3).*
  - 12 *Total Net Accumulated (Credit) or Obligation is the sum of the Western Net Accumulated (Credit) or Obligation and the Plaintiff Net Accumulated (Credit).*
- 
- a *In 2004 Western acquired 6,000 acre-feet of imported water from MWDSC and the Riverside Court approved a Judgment Paragraph VI(b)6 agreement granting the right for Western to extract 6,000 acre-feet of water and the right to transfer such right to Plaintiffs. 3,500 acre-feet of the imported water was stored in the San Bernardino Basin Area.*
  - b *In 2005 the remainder (2,500 acre-feet) of imported water was stored in the Basin.*
  - c *In 2007 Western transferred the right to extract 2,459 acre-feet of imported water to City of Riverside.*
  - d *In 2009 Western acquired 2,459 acre-feet of imported water from San Bernardino Valley and it was stored in the Basin.*
  - e *In 2013 City of Riverside transferred 2,459 acre-feet of water to a Western imported water holding account.*

ANNUAL ACCOUNTING FOR  
 ADDITIONAL EXTRACTIONS OF NEW CONSERVATION WATER AND IMPORTED WATER  
 FROM SAN BERNARDINO BASIN AREA  
 BY CITY OF RIVERSIDE

(All Values in Acre-Feet)

	Calendar Years				
	2009	2010	2011	2012	2013
<b>ADDITIONAL EXTRACTIONS</b>					
New Conservation Allocation	1	0	0	0	9,635 <i>c</i>
Imported Water Assigned By Western	2	0	0	0	0
Additional Extractions	3	0	0	0	0
<b>CREDITS</b>					
New Conservation Allocation	1	0	0	0	9,635 <i>c</i>
Imported Water Transfer From Western	4	0	0	0	0
Imported Water Transfer To Holding Account	5	0	0	0	2,459 <i>d</i>
<b>Total Credits</b>		0	0	0	12,094
<b>ACCUMULATED CREDITS</b>	6	2,459	2,459	2,459	14,553
<b>OBLIGATIONS</b>					
New Conservation Additional Extractions	7	0	0	0	0
Imported Water Additional Extractions	8	0	0	0	0
<b>Total Obligations</b>		0	0	0	0
<b>ACCUMULATED OBLIGATIONS</b>	9	2,459	2,459	2,459	2,459
<b>(CREDIT)</b>	10	0	0	0	(12,094)
<b>NEW CONSERVATION NET ACCUMULATED (CREDIT)</b>	11	0	0	0	(9,635)
<b>IMPORTED WATER NET ACCUMULATED (CREDIT)</b>	12	0	0	0	(2,459)
<b>TOTAL NET ACCUMULATED (CREDIT)</b>	13	0	0	0	(12,094)

ANNUAL ACCOUNTING FOR  
ADDITIONAL EXTRACTIONS OF NEW CONSERVATION WATER AND IMPORTED WATER  
FROM SAN BERNARDINO BASIN AREA  
BY CITY OF RIVERSIDE

- 1 *Amount of new conservation water that is in addition to the amount included in the Plaintiffs Adjusted Right, that is provided for in Judgment Paragraph VI(b)6 agreements.*
  - 2 *Amount of Western's right to extract that is imported water assigned and transferred by Western to a Plaintiff pursuant to Paragraph 5 of the 2004 Judgment Paragraph VI(b)6 agreement.*
  - 3 *Total amount of new conservation and/or imported water extracted by Plaintiff.*
  - 4 *Amount of right to extract imported water acquired from Western and transferred to Plaintiff pursuant to Paragraph 5 of the 2004 Judgment Paragraph VI(b)6 agreement. Amount equals imported water acquired by Plaintiff (see Footnote 2).*
  - 5 *Amount of water transferred from Plaintiff to a Western imported water holding account equal to Plaintiffs unused water right in any five year period (under extraction) provided the amount transferred, plus the remaining balance of any previous such transfers, does not exceed the aggregate amount of imported water acquired by Plaintiff and the right to extract such amount transferred to Plaintiff (see Footnotes 2 and 4) pursuant to the 2004 Judgment Paragraph VI(b)6 agreement. Such holding account transfers are pursuant to Paragraph 11 of the 2013 Judgment Paragraph VI(b)6 agreement.*
  - 6 *Accumulated Credits include amounts of credit accumulated prior to the current five year period.*
  - 7 *Amount of new conservation water extracted by the City of Riverside that is in addition to the new conservation water included in the Adjusted Right. Such amount is included in Additional Deliveries in Table No. 3A-2.*
  - 8 *Amount of imported water extracted by City of Riverside that is transferred by Western to the City of Riverside (see Footnote 4) and previously transferred into the Western holding account (see Footnote 5). Such amount is included in Additional Deliveries in Table No. 3A-2.*
  - 9 *Accumulated Obligations include extraction related obligations accumulated for the current five year period and prior years.*
  - 10 *Credit equals Total Obligation minus Total Credits for the calendar year.*
  - 11 *New Conservation Net Accumulated (Credit) equals the sum of all annual amounts of New Conservation Additional Extractions (see Footnote 7) minus the sum of all annual amounts of New Conservation Allocation (see Footnote 1), including such amounts accumulated prior to the current five year period. Such credit amount is the remaining balance in the City of Riverside new conservation water account.*
  - 12 *Imported Water Net Accumulated (Credit) equals the sum of all annual amounts of Imported Water Additional Extractions (see Footnote 8) minus the sum of all annual amounts of Imported Water Transfer From Western (see Footnote 4) minus Imported Water Transfer To Holding Account (see Footnote 5), including such amounts accumulated prior to the current five year period. Such credit amount is the remaining balance of water in the Western imported water holding account that is available for extraction by City of Riverside.*
  - 13 *Total Net Accumulated (Credit) is the sum of the new conservation credit remaining balance and the imported water credit remaining balance.*
- 
- a *In 2007 Western assigned and transferred the right to extract 2,459 acre-feet of imported water to City of Riverside.*
  - b *In 2007 City of Riverside extracted 2,459 acre-feet more than its Adjusted Right. See Table No. 3A-2.*
  - c *In 2013 Watermaster determined that operation of Seven Oaks Reservoir and downstream spreading grounds resulted in new conservation in the San Bernardino Basin Area during the period 1998 through 2012. The amount shown is the amount of such new conservation water allocated to City of Riverside pursuant to Paragraph 3(a) of the 2013 Agreement Regarding Additional Extractions of New Conservation Water From The San Bernardino Basin Area.*
  - d *In 2013 City of Riverside extracted less than its Adjusted Right and opted to transfer to Western previously transferred right to extract imported water of the amount shown pursuant to Paragraph 11 of the agreement cited in Footnote c above.*

ANNUAL ACCOUNTING FOR  
 ADDITIONAL EXTRACTIONS OF NEW CONSERVATION WATER AND IMPORTED WATER  
 FROM SAN BERNARDINO BASIN AREA  
 BY RIVERSIDE HIGHLAND WATER COMPANY

(All Values in Acre-Feet)

	Calendar Years					
	2009	2010	2011	2012	2013	
<b>ADDITIONAL EXTRACTIONS</b>						
New Conservation Allocation	1	0	0	0	0	793 <i>a</i>
Imported Water Assigned By Western	2	0	0	0	0	0
Additional Extractions	3	0	0	0	0	0
<b>CREDITS</b>						
New Conservation Allocation	1	0	0	0	0	793 <i>a</i>
Imported Water Transfer From Western	4	0	0	0	0	0
Imported Water Transfer To Holding Account	5	0	0	0	0	0
<b>Total Credits</b>		0	0	0	0	793
<b>ACCUMULATED CREDITS</b>	6	0	0	0	0	793
<b>OBLIGATIONS</b>						
New Conservation Additional Extractions	7	0	0	0	0	0
Imported Water Additional Extractions	8	0	0	0	0	0
<b>Total Obligations</b>		0	0	0	0	0
<b>ACCUMULATED OBLIGATIONS</b>	9	0	0	0	0	0
<b>(CREDIT)</b>	10	0	0	0	0	(793)
<b>NEW CONSERVATION</b>						
<b>NET ACCUMULATED (CREDIT)</b>	11	0	0	0	0	(793)
<b>IMPORTED WATER</b>						
<b>NET ACCUMULATED (CREDIT)</b>	12	0	0	0	0	0
<b>TOTAL</b>						
<b>NET ACCUMULATED (CREDIT)</b>	13	0	0	0	0	(793)

ANNUAL ACCOUNTING FOR  
 ADDITIONAL EXTRACTIONS OF NEW CONSERVATION WATER AND IMPORTED WATER  
 FROM SAN BERNARDINO BASIN AREA  
 BY RIVERSIDE HIGHLAND WATER COMPANY

- 1 *Amount of new conservation water that is in addition to the amount included in the Plaintiffs Adjusted Right, that is provided for in Judgment Paragraph VI(b)6 agreements.*
- 2 *Amount of Western's right to extract that is imported water assigned and transferred by Western to a Plaintiff pursuant to Paragraph 5 of the 2004 Judgment Paragraph VI(b)6 agreement.*
- 3 *Total amount of new conservation and/or imported water extracted by Plaintiff.*
- 4 *Amount of right to extract imported water acquired from Western and transferred to Plaintiff pursuant to Paragraph 5 of the 2004 Judgment Paragraph VI(b)6 agreement. Amount equals imported water acquired by Plaintiff (see Footnote 2).*
- 5 *Amount of water transferred from Plaintiff to a Western imported water holding account equal to Plaintiffs unused water right in any five year period (under extraction) provided the amount transferred, plus the remaining balance of any previous such transfers, does not exceed the aggregate amount of imported water acquired by Plaintiff and the right to extract such amount transferred to Plaintiff (see Footnotes 2 and 4) pursuant to the 2004 Judgment Paragraph VI(b)6 agreement. Such holding account transfers are pursuant to Paragraph 11 of the 2013 Judgment Paragraph VI(b)6 agreement.*
- 6 *Accumulated Credits include amounts of credit accumulated prior to the current five year period.*
- 7 *Amount of new conservation water extracted by the Riverside Highland Water Company that is in addition to the new conservation water included in the Adjusted Right. Such amount is included in Additional Deliveries in Table No. 3B-2.*
- 8 *Amount of imported water extracted by Riverside Highland Water Company that is transferred by Western to the Riverside Highland Water Company (see Footnote 4) and previously transferred into the Western holding account (see Footnote 5). Such amount is included in Additional Deliveries in Table No. 3B-2.*
- 9 *Accumulated Obligations include extraction related obligations accumulated for the current five year period and prior years.*
- 10 *Credit equals Total Obligation minus Total Credits for the calendar year.*
- 11 *New Conservation Net Accumulated (Credit) equals the sum of all annual amounts of New Conservation Additional Extractions (see Footnote 7) minus the sum of all annual amounts of New Conservation Allocation (see Footnote 1), including such amounts accumulated prior to the current five year period. Such credit amount is the remaining balance in the Riverside Highland Water Company new conservation water account.*
- 12 *Imported Water Net Accumulated (Credit) equals the sum of all annual amounts of Imported Water Additional Extractions (see Footnote 8) minus the sum of all annual amounts of Imported Water Transfer From Western (see Footnote 5) minus Imported Water Transfer To Holding (see Footnote 5), including such amounts accumulated prior to the current five year period. Such credit amount is the remaining balance of water in the Western imported water holding account that is available for extraction by Riverside Highland Water Company.*
- 13 *Total Net Accumulated (Credit) is the sum of the new conservation credit remaining balance and the imported water credit remaining balance.*

*a In 2013 Watermaster determined that operation of the Seven Oaks Reservoir and downstream spreading grounds resulted in new conservation in the San Bernardino Basin Area during the period 1998 through 2012. The amount shown is the amount of such new conservation water allocated to Riverside Highland Water Company pursuant to Paragraph 3(c) of the 2013 Agreement Regarding Additional Extractions of New Conservation Water From the San Bernardino Basin Area.*

ANNUAL ACCOUNTING FOR  
 ADDITIONAL EXTRACTIONS OF NEW CONSERVATION WATER AND IMPORTED WATER  
 FROM SAN BERNARDINO BASIN AREA  
 BY AGUA MANSA WATER COMPANY AND MEEKS & DALEY WATER COMPANY

(All Values in Acre-Feet)

	Calendar Years					
	2009	2010	2011	2012	2013	
<b>ADDITIONAL EXTRACTIONS</b>						
New Conservation Allocation	1	0	0	0	0	1,448 <i>a</i>
Imported Water Assigned By Western	2	0	0	0	0	0
Additional Extractions	3	0	0	0	0	0
<b>CREDITS</b>						
New Conservation Allocation	1	0	0	0	0	1,448 <i>a</i>
Imported Water Transfer From Western	4	0	0	0	0	0
Imported Water Transfer To Holding Account	5	0	0	0	0	0
<b>Total Credits</b>		0	0	0	0	1,448
<b>ACCUMULATED CREDITS</b>	6	0	0	0	0	1,448
<b>OBLIGATIONS</b>						
New Conservation Additional Extractions	7	0	0	0	0	0
Imported Water Additional Extractions	8	0	0	0	0	0
<b>Total Obligations</b>		0	0	0	0	0
<b>ACCUMULATED OBLIGATIONS</b>	9	0	0	0	0	0
<b>(CREDIT)</b>	10	0	0	0	0	(1,448)
<b>NEW CONSERVATION</b>						
<b>NET ACCUMULATED (CREDIT)</b>	11	0	0	0	0	(1,448)
<b>IMPORTED WATER</b>						
<b>NET ACCUMULATED (CREDIT)</b>	12	0	0	0	0	0
<b>TOTAL</b>						
<b>NET ACCUMULATED (CREDIT)</b>	13	0	0	0	0	(1,448)

ANNUAL ACCOUNTING FOR  
 ADDITIONAL EXTRACTIONS OF NEW CONSERVATION WATER AND IMPORTED WATER  
 FROM SAN BERNARDINO BASIN AREA  
 BY AGUA MANSA WATER COMPANY AND MEEKS & DALEY WATER COMPANY

- 1 *Amount of new conservation water that is in addition to the amount included in the Plaintiffs Adjusted Right, that is provided for in Judgment Paragraph VI(b)6 agreements.*
  - 2 *Amount of Western's right to extract that is imported water assigned and transferred by Western to a Plaintiff pursuant to Paragraph 5 of the 2004 Judgment Paragraph VI(b)6 agreement.*
  - 3 *Total amount of new conservation and/or imported water extracted by Plaintiff.*
  - 4 *Amount of right to extract imported water acquired from Western and transferred to Plaintiff pursuant to Paragraph 5 of the 2004 Judgment Paragraph VI(b)6 agreement. Amount equals imported water acquired by Plaintiff (see Footnote 2).*
  - 5 *Amount of water transferred from Plaintiff to a Western imported water holding account equal to Plaintiffs unused water right in any five year period (under extraction) provided the amount transferred, plus the remaining balance of any previous such transfers, does not exceed the aggregate amount of imported water acquired by Plaintiff and the right to extract such amount transferred to Plaintiff (see Footnotes 2 and 4) pursuant to the 2004 Judgment Paragraph VI(b)6 agreement. Such holding account transfers are pursuant to Paragraph 11 of the 2013 Judgment Paragraph VI(b)6 agreement.*
  - 6 *Accumulated Credits include amounts of credit accumulated prior to the current five year period.*
  - 7 *Amount of new conservation water extracted by the Agua Mansa Water Company and Meeks & Daley Water Company that is in addition to the new conservation water included in the Adjusted Right. Such amount is included in Additional Deliveries in Table No. 3C-2.*
  - 8 *Amount of imported water extracted by Agua Mansa Water Company and Meeks & Daley Water Company that is transferred by Western to the Agua Mansa Water Company and Meeks & Daley Water Company (see Footnote 4) and previously transferred into the Western holding account (see Footnote 5). Such amount is included in Additional Deliveries in Table No. 3C-2.*
  - 9 *Accumulated Obligations include extraction related obligations accumulated for the current five year period and prior years.*
  - 10 *Credit equals Total Obligation minus Total Credits for the calendar year.*
  - 11 *New Conservation Net Accumulated (Credit) equals the sum of all annual amounts of New Conservation Additional Extractions (see Footnote 7) minus the sum of all annual amounts of New Conservation Allocation (see Footnote 1), including such amounts accumulated prior to the current five year period. Such credit amount is the remaining balance in the Agua Mansa Water Company and Meeks & Daley Water Company new conservation water account.*
  - 12 *Imported Water Net Accumulated (Credit) equals the sum of all annual amounts of Imported Water Additional Extractions (see Footnote 8) minus the sum of all annual amounts of Imported Water Transfer From Western (see Footnote 4) minus Imported Water Transfer To Holding Account (see Footnote 5), including such amounts accumulated prior to the current five year period. Such credit amount is the remaining balance of water in the Western imported water holding account that is available for extraction by Agua Mansa Water Company and Meeks & Daley Water Company.*
  - 13 *Total Net Accumulated (Credit) is the sum of the new conservation credit remaining balance and the imported water credit remaining balance.*
- a *In 2013 Watermaster determined that operation of the Seven Oaks Reservoir and downstream spreading grounds resulted in new conservation in the San Bernardino Basin Area during the period 1998 through 2012. The amount shown is the amount of such new conservation water allocated to Agua Mansa Water Company and Meeks & Daley Water Company pursuant to Paragraph 3(b) of the 2013 Agreement Regarding Additional Extractions of New Conservation Water From the San Bernardino Basin Area.*



ANNUAL ACCOUNTING FOR  
 ADDITIONAL EXTRACTIONS OF NEW CONSERVATION WATER AND IMPORTED WATER  
 FROM SAN BERNARDINO BASIN AREA  
 BY THE REGENTS OF THE UNIVERSITY OF CALIFORNIA

(All Values in Acre-Feet)

	Calendar Years					
	2009	2010	2011	2012	2013	
<b>ADDITIONAL EXTRACTIONS</b>						
New Conservation Allocation	1	0	0	0	0	98 <i>a</i>
Imported Water Assigned By Western	2	0	0	0	0	0
Additional Extractions	3	0	0	0	0	0
<b>CREDITS</b>						
New Conservation Allocation	1	0	0	0	0	98 <i>a</i>
Imported Water Transfer From Western	4	0	0	0	0	0
Imported Water Transfer To Holding Account	5	0	0	0	0	0
<b>Total Credits</b>		0	0	0	0	98
<b>ACCUMULATED CREDITS</b>	6	0	0	0	0	98
<b>OBLIGATIONS</b>						
New Conservation Additional Extractions	7	0	0	0	0	0
Imported Water Additional Extractions	8	0	0	0	0	0
<b>Total Obligations</b>		0	0	0	0	0
<b>ACCUMULATED OBLIGATIONS</b>	9	0	0	0	0	0
<b>(CREDIT)</b>	10	0	0	0	0	(98)
<b>NEW CONSERVATION</b>						
<b>NET ACCUMULATED (CREDIT)</b>	11	0	0	0	0	(98)
<b>IMPORTED WATER</b>						
<b>NET ACCUMULATED (CREDIT)</b>	12	0	0	0	0	0
<b>TOTAL</b>						
<b>NET ACCUMULATED (CREDIT)</b>	13	0	0	0	0	(98)

ANNUAL ACCOUNTING FOR  
 ADDITIONAL EXTRACTIONS OF NEW CONSERVATION WATER AND IMPORTED WATER  
 FROM SAN BERNARDINO BASIN AREA  
 BY THE REGENTS OF THE UNIVERSITY OF CALIFORNIA

- 1 *Amount of new conservation water that is in addition to the amount included in the Plaintiffs Adjusted Right, that is provided for in Judgment Paragraph VI(b)6 agreements.*
  - 2 *Amount of Western's right to extract that is imported water assigned and transferred by Western to a Plaintiff pursuant to Paragraph 5 of the 2004 Judgment Paragraph VI(b)6 agreement.*
  - 3 *Total amount of new conservation and/or imported water extracted by Plaintiff.*
  - 4 *Amount of right to extract imported water acquired from Western and transferred to Plaintiff pursuant to Paragraph 5 of the 2004 Judgment Paragraph VI(b)6 agreement. Amount equals imported water acquired by Plaintiff (see Footnote 2).*
  - 5 *Amount of water transferred from Plaintiff to a Western imported water holding account equal to Plaintiffs unused water right in any five year period (under extraction) provided the amount transferred, plus the remaining balance of any previous such transfers, does not exceed the aggregate amount of imported water acquired by Plaintiff and the right to extract such amount transferred to Plaintiff (see Footnotes 2 and 4) pursuant to the 2004 Judgment Paragraph VI(b)6 agreement. Such holding account transfers are pursuant to Paragraph 11 of the 2013 Judgment Paragraph VI(b)6 agreement.*
  - 6 *Accumulated Credits include amounts of credit accumulated prior to the current five year period.*
  - 7 *Amount of new conservation water extracted by The Regents of the University of California that is in addition to the new conservation water included in the Adjusted Right. Such amount is included in Additional Deliveries in Table No. 3D-2.*
  - 8 *Amount of imported water extracted by The Regents of the University of California that is transferred by Western to The Regents of the University of California (see Footnote 4) and previously transferred into the Western holding account (see Footnote 5). Such amount is included in Additional Deliveries in Table No. 3D-2.*
  - 9 *Accumulated Obligations include extraction related obligations accumulated for the current five year period and prior years.*
  - 10 *Credit equals Total Obligation minus Total Credits for the calendar year.*
  - 11 *New Conservation Net Accumulated (Credit) equals the sum of all annual amounts of New Conservation Additional Extractions (see Footnote 7) minus the sum of all annual amounts of New Conservation Allocation (see Footnote 1), including such amounts accumulated prior to the current five year period. Such credit amount is the remaining balance in the The Regents of the University of California new conservation water account.*
  - 12 *Imported Water Net Accumulated (Credit) equals the sum of all annual amounts of Imported Water Additional Extractions (see Footnote 8) minus the sum of all annual amounts of Imported Water Transfer From Western (see Footnote 4) minus Imported Water Transfer To Holding Account (see Footnote 5), including such amounts accumulated prior to the current five year period. Such credit amount is the remaining balance of water in the Western imported water holding account that is available for extraction by The Regents of the University of California.*
  - 13 *Total Net Accumulated (Credit) is the sum of the new conservation credit remaining balance and the imported water credit remaining balance.*
- a *In 2013 Watermaster determined that operation of the Seven Oaks Reservoir and downstream spreading grounds resulted in new conservation in the San Bernardino Basin Area during the period 1998 through 2012. The amount shown is the amount of such new conservation water allocated to The Regents of the University of California pursuant to Paragraph 3(d) of the 2013 Agreement Regarding Additional Extractions of New Conservation Water From the San Bernardino Basin Area.*

ANNUAL ACCOUNTING FOR  
 ADDITIONAL EXTRACTIONS OF NEW CONSERVATION WATER  
 FROM SAN BERNARDINO BASIN AREA  
 BY ENTITIES IN SAN BERNARDINO COUNTY OTHER THAN PLAINTIFFS

(All Values in Acre-Feet)

		Calendar Years				
		2009	2010	2011	2012	2013
<b>ADDITIONAL EXTRACTIONS</b>						
New Conservation Allocation	1	0	0	0	0	30,866 <i>a</i>
Additional Extractions	2	0	0	0	0	17,815 <i>b</i>
<b>CREDITS</b>						
New Conservation Allocation	1	0	0	0	0	30,866 <i>a</i>
Transfer	3	0	0	0	0	0
<b>Total Credits</b>		0	0	0	0	30,866
<b>ACCUMULATED CREDITS</b>	4	0	0	0	0	30,866
<b>OBLIGATIONS</b>						
New Conservation Additional Extractions	2	0	0	0	0	17,815 <i>b</i>
Transfer	5	0	0	0	0	0
<b>Total Obligations</b>		0	0	0	0	17,815
<b>ACCUMULATED OBLIGATIONS</b>	4	0	0	0	0	17,815
<b>(CREDIT)</b>	6	0	0	0	0	(13,051)
<b>NEW CONSERVATION NET ACCUMULATED (CREDIT)</b>	7	0	0	0	0	(13,051)

ANNUAL ACCOUNTING FOR  
 ADDITIONAL EXTRACTIONS OF NEW CONSERVATION WATER  
 FROM SAN BERNARDINO BASIN AREA  
 BY ENTITIES IN SAN BERNARDINO COUNTY OTHER THAN PLAINTIFFS

- 1 Amount of new conservation water that is in addition to the amount included in San Bernardino Valley's Adjusted Right, that is provided for in Judgment Paragraph VI(b)6 agreements.*
- 2 Amount of new conservation water extracted by users in San Bernardino County.*
- 3 Amount of new conservation water transferred to San Bernardino Valley's new conservation account.*
- 4 Accumulated Credit and Accumulated Obligations include amounts accumulated prior to the current five-year period.*
- 5 Amount of new conservation water transferred from San Bernardino Valley's new conservation account.*
- 6 Credit equals Total Obligations minus Total Credits for the calendar year.*
- 7 New Conservation Net Accumulated (Credit) equals the sum of all annual amounts of New Conservation Additional Extractions and Transfers from San Bernardino Valley (see Footnotes 2 and 5) minus the sum of all amounts of New Conservation Allocation and Transfers to San Bernardino Valley (see Footnotes 1 and 3), including such amounts accumulated prior to the current five-year period. Such credit amount is the remaining balance in the San Bernardino Valley new conservation account.*
- a In 2013 Watermaster determined that operation of the Seven Oaks Reservoir and downstream spreading grounds resulted in new conservation in the San Bernardino Basin Area during the period 1998 through 2012. The amount shown is the amount of such new conservation water allocated to entities in San Bernardino County other than Plaintiffs pursuant to Paragraph 4 of the 2013 Agreement Regarding Additional Extractions of New Conservation Water From the San Bernardino Basin Area.*
- b In 2013 entities in San Bernardino County other than Plaintiff's extracted 17,815 acre-feet more than San Bernardino Valley's five-year Adjusted Right. See Table No. 2, page 1b of 2.*

ANNUAL ACCOUNTING FOR  
RIVERSIDE BASIN MITIGATION ACCOUNT  
RELATED TO SEVEN OAKS WATER CONSERVED  
IN SAN BERNARDINO BASIN AREA

(All Values in Acre-Feet)

		Calendar Years					
		2009	2010	2011	2012	2013	
<b><u>MITIGATION ACCOUNT ADDITIONS</u></b>	<b>1</b>						
Long Term Forecast Annual Average Amounts Included Pursuant to Footnote	2	0	0	0	0	483	12
Specific Year Amounts Included Pursuant to Footnote	3	0	0	0	0	2,713	13
<b>Total Mitigation Account Additions</b>	<b>4</b>	0	0	0	0	3,196	
<b>ACCUMULATED MITIGATION ACCOUNT ADDITIONS</b>	<b>5</b>	0	0	0	0	3,196	
<b><u>MITIGATION ACCOUNT EXTRACTIONS</u></b>	<b>6</b>						
Extractions by City of Riverside	7	0	0	0	0	0	
Extractions by Other Than Plaintiffs	8	0	0	0	0	0	
<b>Total Mitigation Account Extractions</b>	<b>9</b>	0	0	0	0	0	
<b>ACCUMULATED MITIGATION ACCOUNT EXTRACTIONS</b>	<b>10</b>	0	0	0	0	0	
<b>MITIGATION ACCOUNT BALANCE</b>	<b>11</b>	0	0	0	0	3,196	

ANNUAL ACCOUNTING FOR  
RIVERSIDE BASIN MITIGATION ACCOUNT  
RELATED TO SEVEN OAKS WATER CONSERVED  
IN SAN BERNARDINO BASIN AREA

- 1 Pursuant to the 2013 Agreement Regarding Additional Extractions of New Conservation Water From the San Bernardino Basin Area (Basin) (2013 Agreement), any amount of replenishment in the Basin resulting from operation of Seven Oaks Dam and related diversion and spreading facilities that, in the absence of such operation, would have been replenished in the Riverside Basin, shall be included in a Riverside Basin Mitigation Account. Such water is referred to herein as Mitigation Water.
- 2 Equal annual average amounts of Mitigation Water determined on the basis of a long term forecast of Seven Oaks related conservation at the Santa Ana River Spreading Grounds. Pursuant to the 2013 Agreement, such forecasts are subject to periodic change and hence the otherwise equal annual amounts may change periodically.
- 3 Specific amounts of Mitigation Water resulting from a determination of prior years (1998-2012) new conservation and any determination of new conservation resulting from conservation through direct use, recharge in the Basin in areas other than the Santa Ana River Spreading Grounds and/or export from the Basin and subsequent return for direct use or recharge.
- 4 Long Term Forecast Annual Average Amounts plus Specific Year Amounts.
- 5 Accumulated amount of Mitigation Account Additions includes amounts accumulated prior to the current five-year period.
- 6 Pursuant to the 2013 Agreement, the City of Riverside may be required to extract San Bernardino Basin Area water that is included in the Mitigation Account and reduce extractions in its Flume Tract wells in the Riverside Basin by the same amount. Similarly, San Bernardino Valley may choose to extract water that is included in the Mitigation Account and deliver it for recharge in the Riverside Basin.
- 7 Amounts of Mitigation Water extracted by City of Riverside pursuant to the 2013 Agreement.
- 8 Amounts of Mitigation Water extracted by any producer other than Plaintiffs for delivery and recharge in the Riverside Basin.
- 9 Extractions by City of Riverside plus Extractions by Other Than Plaintiffs.
- 10 Accumulated amount of Mitigation Account Extractions includes amounts accumulated prior to the current five-year period.
- 11 The amount of Mitigation Water Additions to the Mitigation Account minus the amount of Mitigation Water Extractions from the Mitigation Account by City of Riverside and by Other Than Plaintiffs in San Bernardino County.
- 12 Based on calculations by GEOSCIENCE/SAIC in an August 1, 2013 Technical Memorandum to Western and San Bernardino Valley, Watermaster determined that 483 acre-feet/year of Mitigation Water should be included in the Riverside Basin Mitigation Account based on the current maximum spreading grounds diversion rate of 195 cfs. Inclusion of such annual average amount of Mitigation Water continues annually until another long term forecast results in a change.
- 13 Based on calculations by GEOSCIENCE/SAIC in an August 1, 2013 Technical Memorandum to Western and San Bernardino Valley, Watermaster determined that during prior years 1998-2012, 2,713 acre-feet of Mitigation Water should be included in the Riverside Basin Mitigation Account.

TABLE NO. 18

SUMMARY OF COMPLIANCE WITH FOUR  
PRINCIPAL PROVISIONS OF THE JUDGMENT

■ PLAINTIFF EXTRACTIONS ARE LESS THAN THE  
MAXIMUM ALLOWABLE EXTRACTIONS

During the five-year period 2009 through 2013 extractions by Plaintiffs did not exceed the five-year maximum allowable. (See page 2b of 2 of Table Nos. 10 through 13) Also, in calendar year 2013 extractions by each Plaintiff did not exceed the annual maximum allowable, which is 1.3 times the 2013 Adjusted Right. (See page 1b of 2 of Table Nos. 10 through 13)

■ SAN BERNARDINO VALLEY IS NOT REQUIRED TO  
PROVIDE REPLENISHMENT

For the period 1971 through 2013, San Bernardino Valley credits exceed obligation by 163,154 AF. (See Table No. 17)

**COMPLIANCE IN THE COLTON AND RIVERSIDE BASIN AREAS**

■ WESTERN IS NOT REQUIRED TO PROVIDE  
REPLENISHMENT

For the period 1971 through 2013, Western credits exceed obligations by 454,393 AF. (See Table No. 16)

■ SAN BERNARDINO VALLEY IS NOT REQUIRED TO  
PROVIDE REPLENISHMENT FOR MAINTAINING  
GROUNDWATER LEVEL

The average lowest water level in the three key wells for calendar year 2013 is 13.43 feet higher than the required minimum average level of 822.04 feet. (See Chapter V)